

DATSUN 200B

OWNER'S MANUAL MODEL 810 SERIES

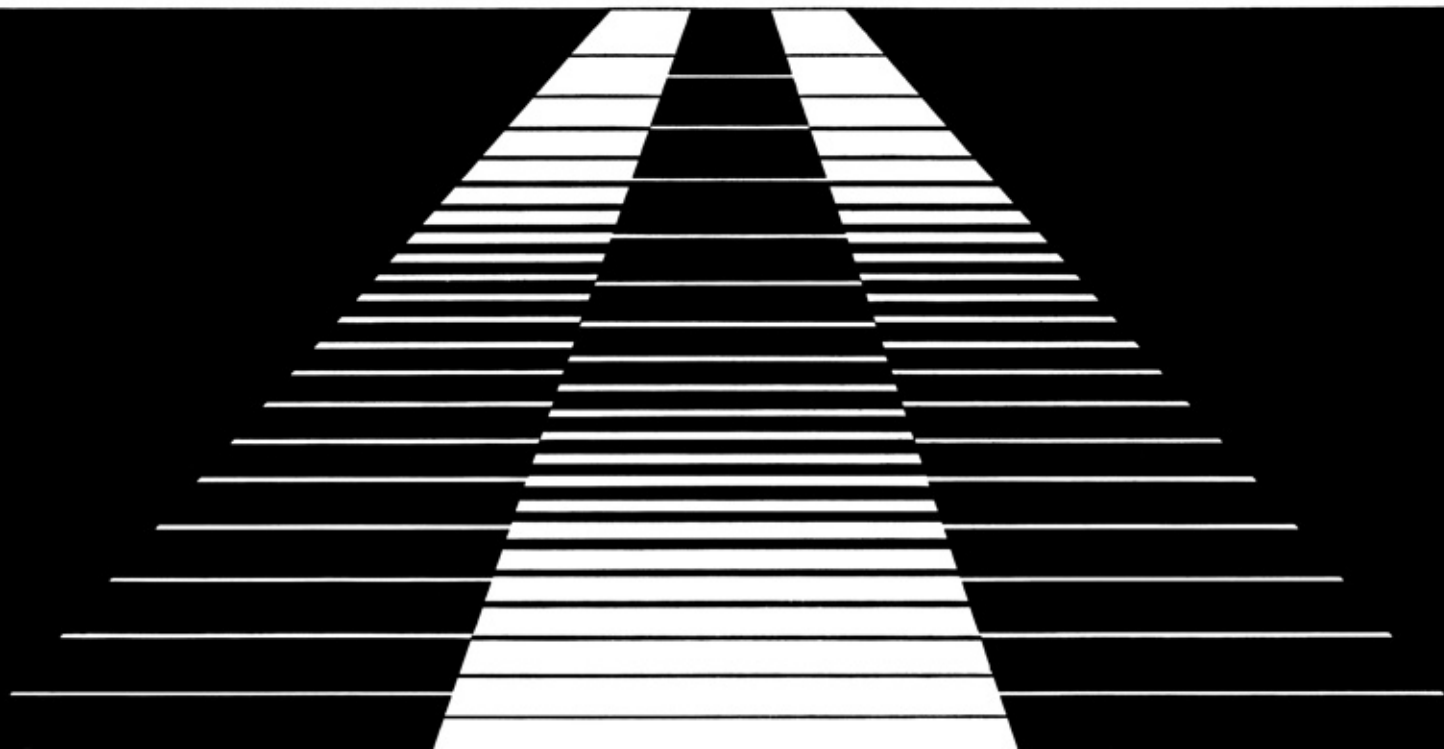

A Word To DATSUN Owners



Thank you for choosing a DATSUN.

We are sure you will be happy with your choice. In this manual we have included driving tips, information about the location and purpose of dashboard instruments, comfort and safety features, and other details that will help you know your DATSUN.

Before your Dealer delivers your DATSUN to you, he gives it a careful pre-delivery inspection, checking and servicing the car to be sure it is ready for the road.

We recommend that you return it to him for regular servicing, in accordance with the Maintenance Schedule in this manual.

Your Dealer will validate the Warranty and Service Booklet thus confirming that your car has been maintained to Factory standards.

Please keep the Warranty and Service Booklet in the glove box of your car at all times.

Remember, your NISSAN/DATSUN Dealer uses only Genuine NISSAN Parts, he is kept informed of every new technical development and his Technicians are NISSAN trained to service your car the right way.

You are his customer and he wants to keep it that way.

Doesn't all this make your NISSAN/DATSUN Dealer the place to take your car for service?

All information, specifications and illustrations in this manual are the latest data obtainable at the time of publication. NISSAN reserves the right to make changes or improvements at any time without notice.

This Owner's Manual has been prepared on the assumption that your car is fully equipped (including all factory optional equipment). Thus if you have any questions regarding equipment, please contact your authorized DATSUN Dealer.

When planning to travel in another country you should first find out if the octane rating of the gasoline available there is suitable for your car's engine. Using gasoline with too low an octane rating may cause engine damage. Therefore, avoid taking your car to areas where gasoline of the appropriate octane is not available.

Also, before attempting to register your car in another country, you should check that country's regulations and requirements to make sure that your car will be able to meet all of them.

Contents

Before Driving Your Datsun	2
Instruments and Controls	12
Starting and Operating	23
Comfort and Convenience Features	33
In Case of Emergency	45
Maintenance	48
Emission Control Systems	68
Specifications	83
Index	92

Before Driving Your Datsun

Familiarize yourself with all the DATSUN features and safe-driving procedures.

SAFETY CHECKS

Before driving your DATSUN, be sure to check all the safety items mentioned below.

– Before entering the car –

- Check that all windows and light lenses are clean.
- Visually inspect tires for condition. Also check tire inflation pressures.
- Check that area around car is clear before driving off.

– After entering the car –

- Lock all doors.
- Position seats.
- Fasten seat belts.
- Adjust inside and outside mirrors.
- Check the operation of lights, switches and horn.
- Check the operation of warning lights when key is turned to “ON” position.

Fluid levels such as engine oil, engine coolant, brake and clutch fluid and windshield washer fluid should be checked daily and/or weekly, or whenever you refuel.

Further details are described in “Routine Service” under the heading “Maintenance”.

Before Driving Your Datsun

KEYS

Your keys operate the various locks on your DATSUN.

Record the key number so your NISSAN/DATSUN dealer will be able to replace a lost key.



DR212

Ignition switch
Steering lock



DR213

Door lock
Trunk lid/Tailgate lock
Fuel filler lid lock
Glove box lock

DOOR LOCKS

Sedan, Hardtop and Station Wagon

To lock the door insert the key and turn it toward the front of the car. Turn the key toward the rear of the car to unlock the door.

Note: Be sure to remove the key before you apply all door locks from outside.

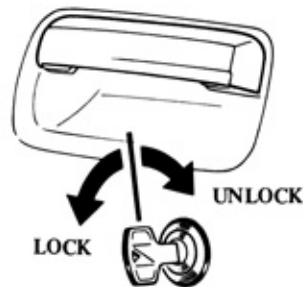

DR279

[From inside – Sedan and Station Wagon]

To lock a door from the inside of the car, push the lock button down. To unlock, pull the button up.

The front doors will not lock, even if the buttons are pushed down before you close the door. This is to prevent your accidentally locking your key inside the car.

Front doors, however, can be locked without key from outside by first pushing the lock button down, pulling outside door handle and closing the door.

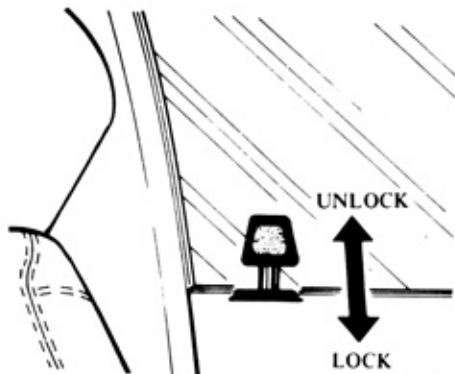

DR215

Before Driving Your Datsun

[From inside – Hardtop]

To lock a door from the inside of the car, place the lock knob on the "Lock" position. To unlock, place it on the "Off" position.

Front doors can be locked without key by doing the same procedure mentioned before.

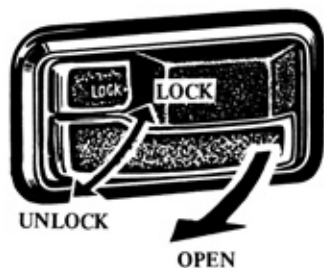

DR258

FUEL FILLER LID LOCK

To open the fuel filler lid, insert the key and turn it clockwise.

To lock, turn it counterclockwise or just push the fuel filler lid firmly.

Do not forget to install the filler cap after refilling.

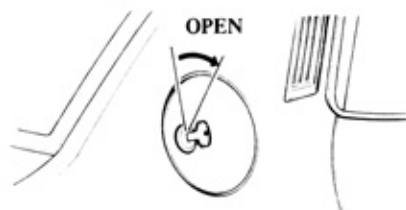

DR577

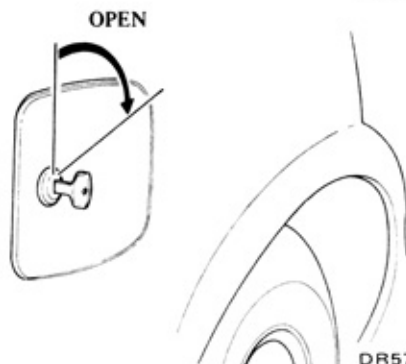

DR578

FRONT SEAT

Fore-aft adjustment

The fore-aft control lever located at the lower front of the seat, releases the seat latch. To adjust the seat position, pull the lever sideward then hold it while you slide the seat forward or backward to the desired position. Release the lever to lock the seat in position.

Caution: Do not adjust the driver's seat while driving. The seat may abruptly jerk forward or backward, which could cause the driver to lose control.

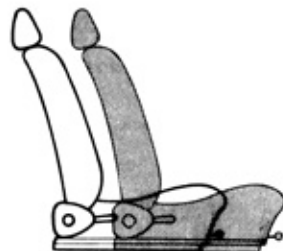

DR260

Before Driving Your Datsun

Reclining seat

Adjust the seat back cushion to any desired position by simply pulling up the lever.

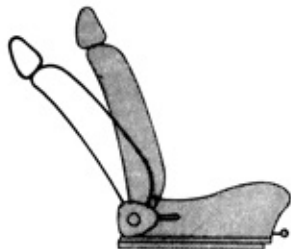

DR261

Seat lifter (Hardtop and Station Wagon)

Adjust the angle of seat cushion to any desired position by simply pulling up the lever.



SA030

Tilting (Hardtop)

For entry to the rear seat, pull the seatback control lever upward. The front seatback tilts forward and the seat slides forward.

The other control lever is provided on the inside of the front passenger seat. Pull the control lever upward to tilt the seatback and slide the seat forward.

To lock the seatback in position, pull it backward. The seatback and seat will then return to their original positions.

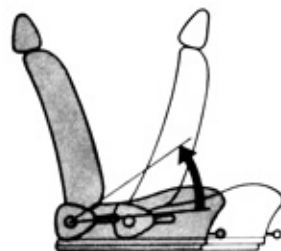

DA280



DR676

Before Driving Your Datsun

HEAD RESTRAINTS

Head restraints are not adjustable and stoppers on stays should not be removed or adjusted.



DR582

SEAT BELTS

Front seat belts

The front seat belts are a three-point type consisting of an inner lap and an outer lap-shoulder belt.

Outer lap-shoulder belt

The outer lap-shoulder belt is provided with an emergency locking retractor (hereafter called ELR).

The ELR is a belt retraction device which locks the belt only if the car becomes involved in a collision or comes to a sudden stop. In normal situations, the ELR allows you to pull the belt out freely. However, when pulled out abruptly, the belt will lock; in such a case, allow it to rewind into the retractor about 25.4 mm (1 in), and then pull it out slowly.

The outer lap-shoulder belt is provided with a tongue holder to prevent the tongue from slipping. Move the tongue holder along the belt to a convenient position.

When getting out of the car, insert the tongue end into the tongue holder as shown in the illustration in order to secure the tongue.

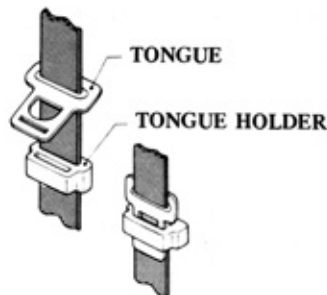

DR644

Inner lap belt

The inner lap belt is a combined unit of a buckle and flexible wire.

Before wearing the belt, adjust the direction of the inner lap belt so that the clearance between the flexible wire and your body is kept to a minimum.

To disconnect the belt, depress the push button located in the buckle. The outboard belts will automatically retract.

Note: The flexible wire should not be bent excessively.

Before Driving Your Datsun

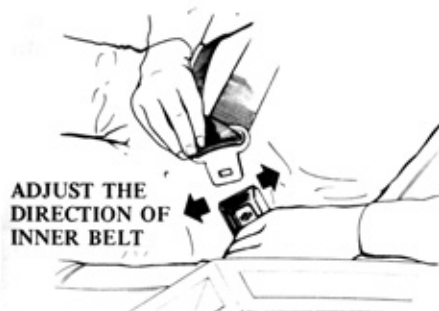

DR687



DR695



DR696

WARNING: No modifications or additions should be made by the user which will either prevent the seat belt adjusting devices from operating to remove slack, or prevent the seat belt assembly from being adjusted to remove slack.

Rear seat belts

The outside seat belts are a three-point type consisting of an inner lap belt and an outer lap-shoulder belt, while the middle seat belt is a two-point type consisting of two lap belts.

When getting out of the car, hang the outer lap-shoulder belt on the storage hook provided next to the upper anchorage location.



DR501

Before Driving Your Datsun

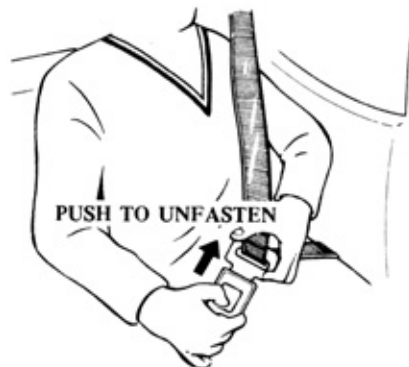

DR502

Adjustment of belts – Rear seat belts

The belts can be adjusted as follows:

- (A) To remove slack from the belt system, pull the free end of the belt.
- (B) To loosen the belt system, lift the front edge of the adjusting device and pull on the belt straps which run through the adjusting device.

WARNING: Seat belts are designed to bear upon the bony structure of the body, and should be worn low across the front of the pelvis, or the pelvis, chest and shoulders, as applicable; wearing the lap section of the belt across the abdominal area must be avoided.

Seat belts should be adjusted as firmly as possible, consistent with comfort, to provide the protection for which they have been designed. A slack belt will greatly reduce the protection afforded to the wearer.

Care should be taken to avoid contamination of the webbing with polishes, oils and chemicals, and particularly battery acid. Cleaning may safely be carried out using mild soap and water. The belt should be replaced if webbing becomes frayed, contaminated or damaged.

It is essential to replace the entire assembly after it has been worn in a severe impact even if damage to the assembly is not obvious.

Belts should not be worn with straps twisted.

Each seat belt assembly must only be used by one occupant; it is dangerous to put a belt around a child being carried on the occupant's lap.

CHILD RESTRAINT

Your car is designed to accommodate a child restraint on the rear seat. When using a child restraint, carefully read and follow the Installation Instructions attached to it.

WARNING: Child restraint anchorages are designed to withstand only those loads imposed by correctly fitted child restraints. Under no circumstances are they to be used for adult seat belts or harnesses.

Anchorage locations

Sedan and Hardtop:

Under slit circles attached to the rear parcel shelf finisher

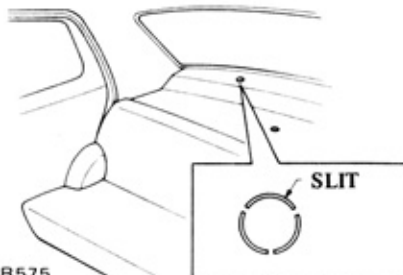

DR575

Station Wagon:

Under slits attached to the floor carpet in the luggage compartment

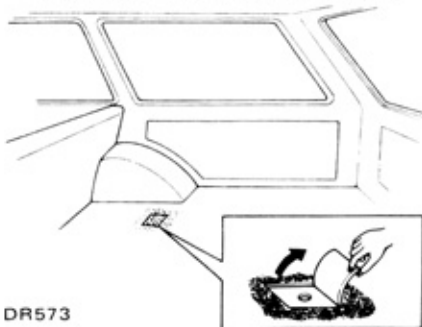

DR573

Removing finisher

To remove the finisher, depress the slit circle with the thumb or a screwdriver's tip (Sedan and Hardtop), or pinch it with the fingertips (Station Wagon).

Note: Use a bolt of 5/16 in. in diameter 18 UNC and 30 mm (1.18 in) in length.

Before Driving Your Datsun

TOWING A TRAILER

Trailer towing not only will place extra stress on your car but also will affect its steering ability, durability and economy. If such a need arises, please consult your DATSUN dealer for an explanation of proper use of towing equipment.

Maximum load limits

Maximum Gross Vehicle Mass of a Trailer (including tires and other loaded equipment)

1. Never exceed the value specified in the following chart:

Trailer with brakes	Trailer without brakes
700 kg (1,544 lb)	400 kg (882 lb)

2. Even if the specified value is not exceeded, it must not be higher than the smallest value of the following three.
 - 1) Towing capacity displayed on a towbar
 - 2) Trailer's gross vehicle mass marked on a coupling body
 - 3) Gross vehicle mass marked on a trailer data plate

Maximum Permissible Tongue Load

Never load the towbar to more than 10% of the loaded trailer mass, or the value specified in the following chart:

Trailer with brakes	Trailer without brakes
70 kg (154 lb)	40 kg (88 lb)

Maximum Permissible Rear Axle Load

Never exceed the gross axle weight rating rear (GAWR).

GAWR	Sedan and Hardtop	799 kg (1,762 lb)
	Station Wagon	864 kg (1,905 lb)

Tire pressure

Ensure that tires are inflated to the maximum recommended pressure.

Safety chain

The safety chain is designed to prevent accidents should the connection between car and trailer fail during tow-

ing. Be sure the chain is slack enough to permit turning corners.

Trailer brakes

Ensure that trailer brakes are installed as required by local regulations. Also check that all other trailer equipment conforms to local regulations.

Operating precautions

- Avoid towing a trailer during the "break-in" period.
- Avoid abrupt starts, accelerations or stops.
- Always drive your car at a moderate speed.
- Have your car serviced more often than at intervals specified in the recommended Maintenance Schedule.

Note: Trailer towing requires more fuel than under normal circumstances because of a considerable increase in traction power and resistance.

REARVIEW MIRRORS

Adjust the outside and inside mirrors before driving. For safe driving rear vision must be unimpaired.

Inside day-night mirror (Except Standard Deluxe)

The inside mirror is designed to break off at its base on impact. The glare-proof type inside rearview mirror can be changed from clear daylight visibility to non-glare visibility by pulling the knob under the mirror.

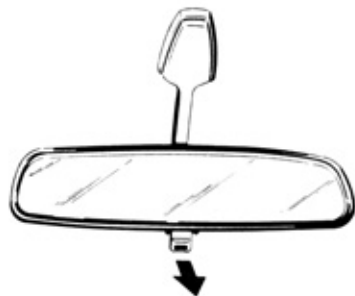

PULL FOR NON-GLARE

RM002

Outside door mirror

The outside mirror can be moved in any direction for better rear vision.



DR697

Instruments and Controls

Sedan and Station Wagon

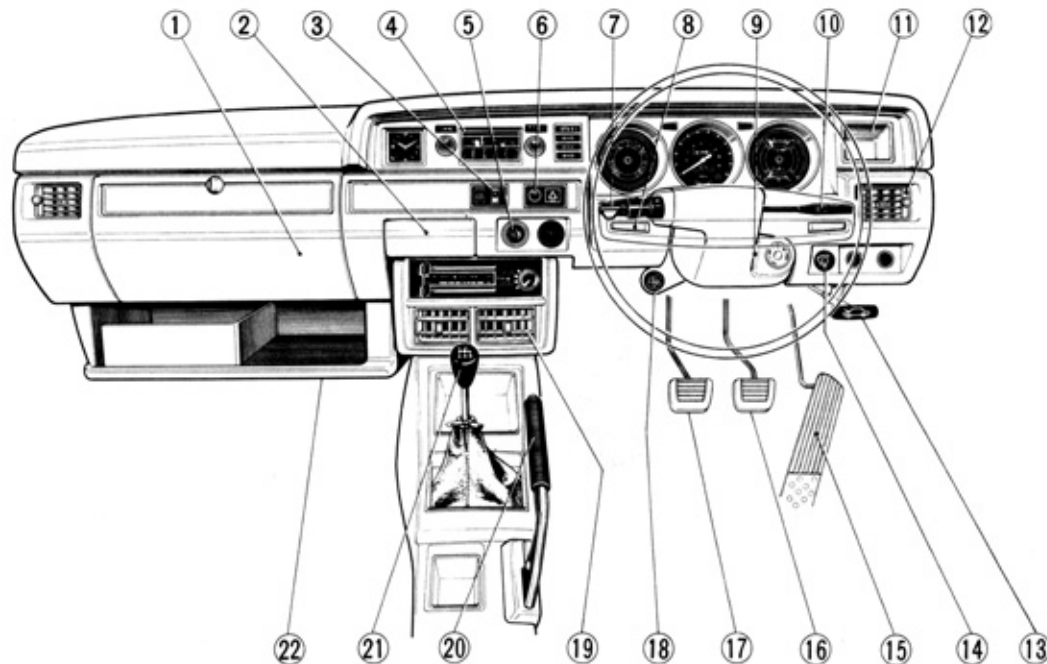

- ① Glove box
- ② Ash tray
- ③ Rear window electric defroster switch (all except standard Deluxe)
- ④ Radio
- ⑤ Cigarette lighter
- ⑥ Hazard warning switch
- ⑦ Wiper and washer switch
- ⑧ Horn button
- ⑨ Ignition key illumination light
- ⑩ Light/turn signal/dimmer passing switch lever
- ⑪ Coin holder
- ⑫ Side ventilator
- ⑬ Hood release handle
- ⑭ Illumination control switch
- ⑮ Accelerator pedal
- ⑯ Brake pedal
- ⑰ Clutch pedal
- ⑱ Rear window wiper (Station Wagon only)
- ⑲ Heater
- ⑳ Parking brake lever
- ㉑ Gear control lever
- ㉒ Package tray

IN810

Instruments and Controls

Hardtop

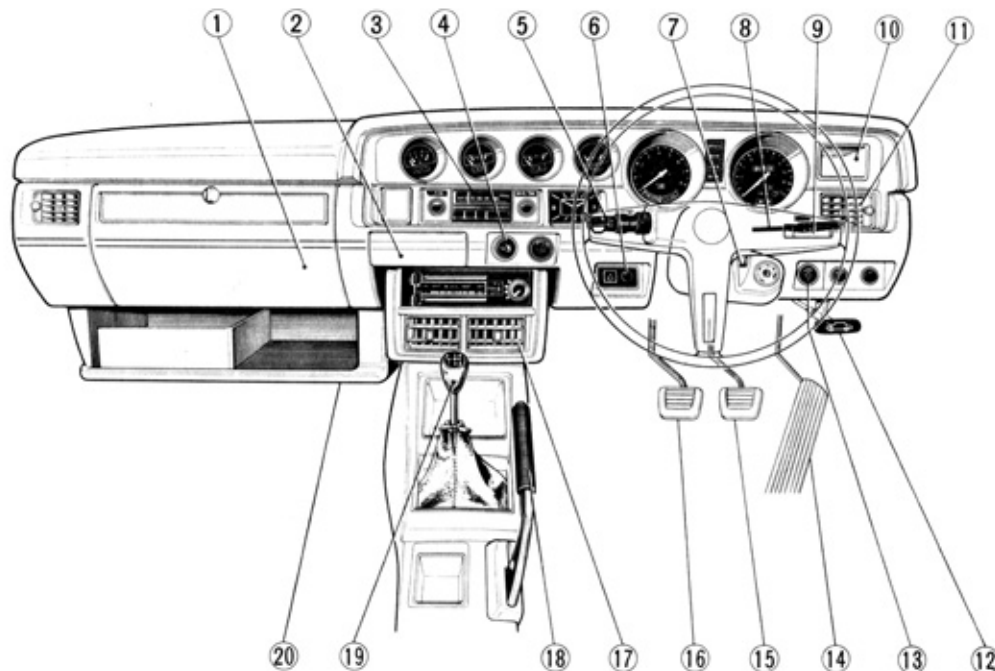

- ① Glove box
- ② Ash tray
- ③ Radio
- ④ Cigarette lighter
- ⑤ Wiper and washer switch
- ⑥ Hazard warning switch
- ⑦ Ignition key illumination light
- ⑧ Light/turn signal/dimmer passing switch lever
- ⑨ Horn button
- ⑩ Coin holder
- ⑪ Side ventilator
- ⑫ Hood release handle
- ⑬ Illumination control switch
- ⑭ Accelerator pedal
- ⑮ Brake pedal
- ⑯ Clutch pedal
- ⑰ Heater
- ⑱ Parking brake lever
- ⑲ Gear control lever
- ⑳ Package tray

IN811

Instruments and Controls

Sedan and Station Wagon

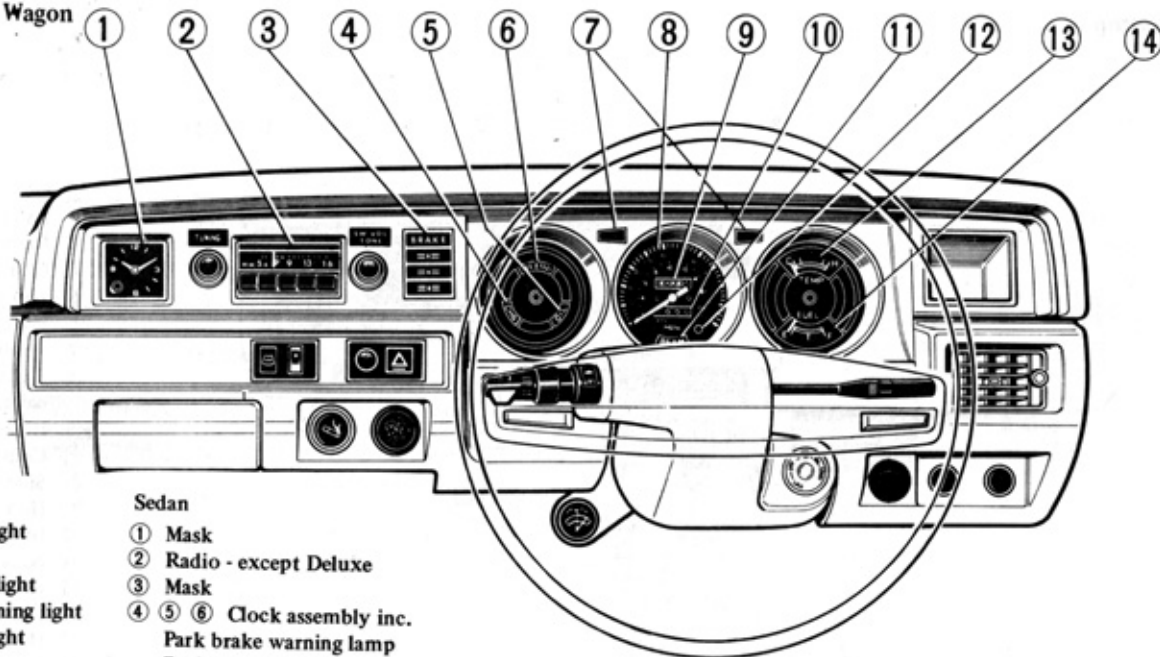

Station Wagon

- ① Clock
- ② Radio
- ③ Brake warning light (Fluid level)
- ④ Charge warning light
- ⑤ Oil pressure warning light
- ⑥ Brake warning light (Parking)
- ⑦ Turn signal indicator lights
- ⑧ Speedometer
- ⑨ Odometer
- ⑩ Tripmeter
- ⑪ High beam indicator light
- ⑫ Tripmeter reset knob
- ⑬ Water temperature gauge
- ⑭ Fuel gauge

Sedan

- ① Mask
- ② Radio - except Deluxe
- ③ Mask
- ④ ⑤ ⑥ Clock assembly inc. Park brake warning lamp Brake warning lamp Oil pressure warning lamp Charge warning lamp
- ⑦ Turn signal indicator lamp
- ⑧ Speedometer and high beam indicator
- ⑨ Odometer
- ⑩ Tripmeter
- ⑫ Tripmeter reset knob
- ⑬ Water temperature gauge
- ⑭ Fuel gauge

IN812

Instruments and Controls

Hardtop

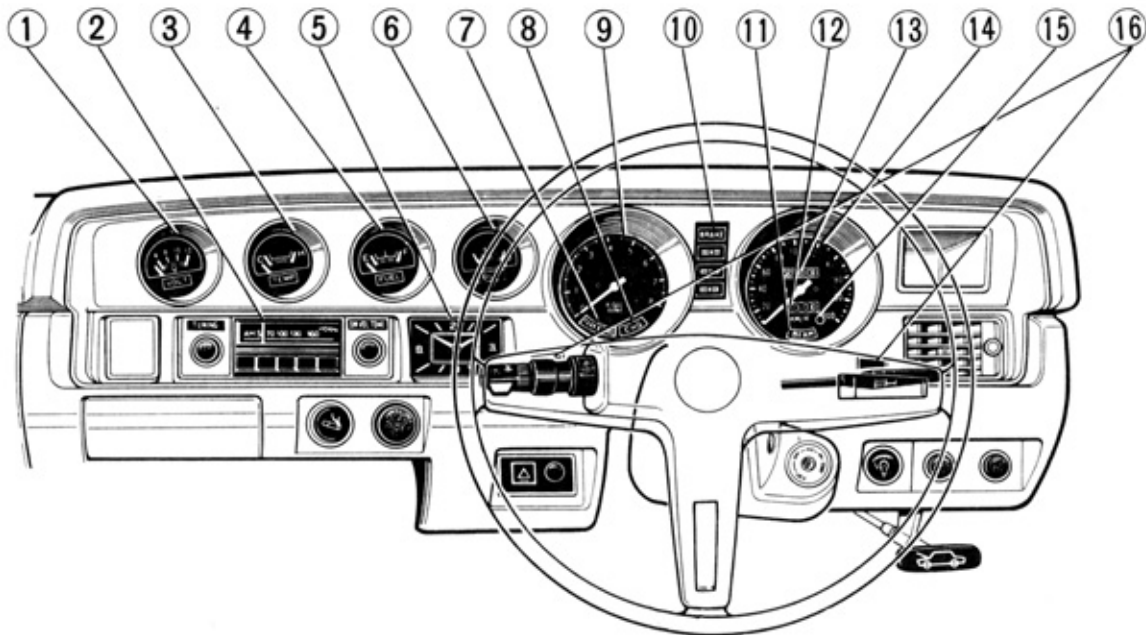

- ① Voltmeter
- ② Radio
- ③ Water temperature gauge
- ④ Fuel gauge
- ⑤ Clock

- ⑥ Oil pressure gauge
- ⑦ Brake warning light (Parking)
- ⑧ Charge warning light
- ⑨ Tachometer
- ⑩ Brake warning light (Fluid level)

- ⑪ High beam indicator light
- ⑫ Tripmeter
- ⑬ Odometer
- ⑭ Speedometer
- ⑮ Tripmeter reset knob
- ⑯ Turn signal indicator lights

1N813

Instruments and Controls

SPEEDOMETER

The speedometer indicates car running speed in kilometers per hour.

The odometer records the total kilometers your car has been driven and is useful for keeping a record of maintenance intervals.

The trip odometer registers the kilometers in total driving distance.

The dial is turned back to zero by pushing the reset button.

TACHOMETER

The tachometer is electrically operated and indicates the engine speed calibrated in thousands of revolution per minute (r.p.m.). Two zones are colored on its face.

For normal driving, it is recommended that your car is driven in the non-color or yellow sector.

Do not drive with the tachometer gauged at red zone, or the engine may be seriously damaged.

FUEL GAUGE

With the ignition switch "ON", the fuel gauge indicates the approximate amount of fuel in the tank. The position of the needle will vary slightly when accelerating, braking, or when the car is going up or downhill. So check your fuel supply when the car is on the flat level, standing still or moving.

WATER TEMPERATURE GAUGE

With the ignition switch "ON," this gauge indicates the temperature of the coolant. Under most driving conditions, the needle will remain at about the half-way point. However, engine performance will be satisfactory when the pointer is at any position in the middle range. Stop-and-go driving, driving at high speeds in warm weather, hill climbing, or towing another car may cause the needle to move toward the "H" side. If the needle should swing all the way to the "H" position and remain there for more than a few minutes, stop the car and cool the engine, keeping it at 1,000 to 1,500 rpm.

OIL PRESSURE GAUGE (Hardtop)

The oil pressure gauge operates and the pointer indicates oil pressure of the lubricant in the engine.

During ordinary driving, the pointer will indicate 98 to 490 kPa (15 to 70 psi).

If the pointer moves abnormally low or shakes frequently, stop the engine immediately and check the lubricant system.

VOLTMETER (Hardtop)

The voltmeter monitors the condition of the charging system and the state of charge of the battery, as outlined below:

- Before starting up the engine

The needle is in the UNCOLORED zone. Normal

The needle is in either the YELLOW or RED zone.

. Check the condition of the battery.

- During starter operation

The needle is in the RED zone. Normal

TURN SIGNAL INDICATOR LIGHT

The needle may sometimes stay within a range of 6 to 8 volts even though nothing is wrong with the battery or charging system.

The needle will fall back as the battery becomes discharged.

While the engine is idling or the car is being driven

The needle is in the UNCOLORED zone. Normal

The needle is in the YELLOW zone. Check the following as necessary:

- Loose fan belt
- Condition of battery and voltage regulator
- Overloading

The needle is in the RED zone. Be sure to check the following:

- Loose fan belt
- Condition of battery and voltage regulator
- Overloading

Two indicator lights are installed on the upper side (lower side for SSS models) of the speedometer and flash simultaneously with the exterior directional indicator lights.

Instruments and Controls

BRAKE WARNING LIGHT

Parking brake system

The warning light will glow when the parking brake is applied with the ignition switch "ON". If it does not glow, check the electrical system for a burned-out bulb or an open circuit.

Foot brake system (Hardtop and Station Wagon)

The foot brake system is designed with a dual circuit, one circuit controlling the front wheels and the other the rear wheels. If one circuit should fail, the other will continue to operate. The warning light glows when the ignition switch is turned to the "ON" or "START" position. If it does not glow, check the electrical system for a burned-out bulb or an open circuit. Depress the brake pedal with the engine running. If the brake warning light glows, the foot brake system is partially inoperative. Have your car repaired immediately. Do not drive unless it is safe, and then only at a reduced speed to the nearest service station.

Instruments and Controls

(Sedan)

The light glows if a pressure difference exists between the front and rear brake systems. If the light glows with the engine running after the brake pedal has been depressed, it indicates that the braking system requires immediate attention. Driving the car in this condition is not recommended.

Brake fluid level indicator system (Hardtop and Station Wagon)

The brake warning light glows if the fluid level is lower than the prescribed level when the engine is running. The service brake system will provide some braking action in the event of a hydraulic leak.

If, while driving, the warning light glows when the foot brake is free, brake fluid level should be checked immediately. Add brake fluid if necessary.

CHARGE (Alternator) WARNING LIGHT

With the ignition switch "ON", the "CHG" warning light glows red if the alternator is not supplying current to the electrical system. After the engine has started, the light should go out, indicating that the alternator is operating properly. The light may glow or flicker occasionally when the engine is idling. However, if the light remains on steadily at normal driving speeds, the alternator and electrical system should be checked.

OIL PRESSURE WARNING LIGHT (Except Hardtop)

If the ignition is switched "ON", the oil pressure warning light will glow red. If does not, the bulb and wiring should be checked. As soon as the engine starts and oil pressure is normal, the light will go out. If oil pressure drops below the safe operating level, the light will glow. After a sudden stop, the light may flicker a few seconds but this is not harmful. However, if the light glows steadily at normal driving speeds, stop the engine immediately and have the lubrication system checked.

HIGH BEAM INDICATOR LIGHT

The headlights have two beams to meet varying night driving conditions. The high beams give better long range visibility.

With the headlights on, the beam indicator shows blue whenever the high beams are used, and goes off when the low beams are selected.

TURN SIGNAL SWITCH

To signal a left turn, push the turn signal switch lever upward (toward the top of the steering wheel). For a right turn signal, pull the lever downward.

With the lever in either position flashing lights, on the front, both sides and rear, indicate to other drivers the direction you intend to turn. Corresponding indicator lights on the dash panel tell you which set of signal lights is operating. Occasionally the turn may be so wide and gradual that the steering wheel will not rotate far enough to cancel the turn indicator after you have completed the turn. If this happens, just flick the lever to its "OFF" position.

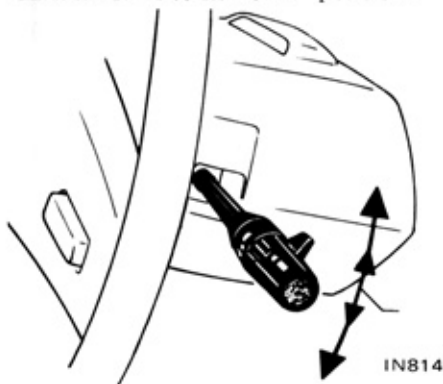

Lane changing

To signal a lane change on a highway, move the turn signal switch lever part-way in the direction of the turn and hold it there until the maneuver is completed. The signal will automatically cancel when the driver releases his hold on the lever.

LIGHT SWITCH

The light switch is located on the instrument panel. Clearance, tail, license, side marker lights (selector lever indicator on car with automatic transmission), heater or air conditioner control indicator, instrument panel lights and headlights are lit by this knob.

With the light switch knob pulled out, the following lights will be lit.

1st position:

- Clearance, tail, license, side marker, automatic transmission control lever indicator, heater or air conditioner control indicator, and instrument panel lights

2nd position:

- Headlights and all the above lights (The headlight beams are controlled by the turn signal lever.)

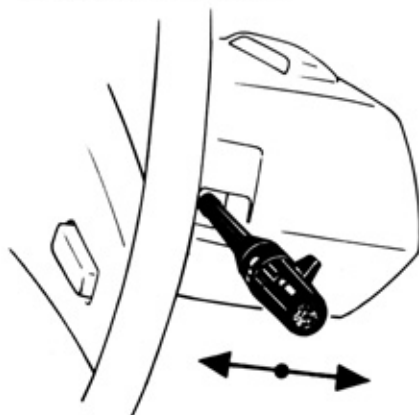

Instruments and Controls

PASSING LIGHT SWITCH

The passing lights will come on when the turn signal lever is moved fully toward the driver, irrespective of the light switch position.

In the daytime, the lights may be flashed to warn other drivers that you wish to pass. At night, alternate the beams between high and low.

IGNITION KEY ILLUMINATION LIGHT

The key illumination light is a special convenience when driving after dark. It is located on the steering column and is turned on when the light switch lever is turned to its first position.

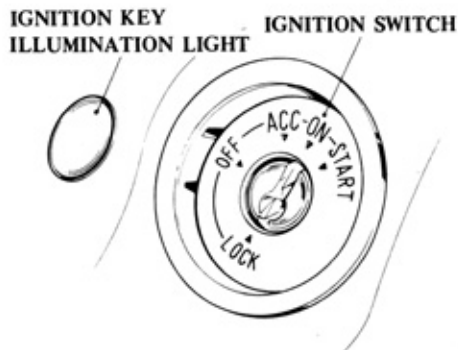

IN786

ILLUMINATION CONTROL RHEOSTAT

The brightness of the instrument lights can be adjusted by turning the control knob.

Turning the knob clockwise will brighten the instrument lights.



IN299

HAZARD WARNING SWITCH

By pulling this knob, all directional indicator lights will flash at the same time, warning other cars of your trouble.

Abuse causes a discharged battery.



IN621

WIPER AND WASHER SWITCH

The windshield wiper is either a two-speed or a three-speed type. In the two-speed type, the first position is for low and the second for high. In the three-speed type, the wiper blades operate intermittently in the first position. The second position is for low speed and the third speed for high.



IN816

The wiper switch also controls the windshield washer.

To operate the washer, push the center knob and hold it until there is enough fluid on the windshield to wash off the dirt.

Do not operate the washer continuously for more than thirty seconds and do not operate the wiper when the windshield is dry or the fluid reservoir is empty.

Do not use radiator anti-freeze in the windshield washer; it may cause paint damage.

Instruments and Controls REAR WINDOW WIPER AND WASHER SWITCH

Station Wagon only

The rear window wiper is of a one-speed electric type. Pull the switch knob to turn on the wiper. To actuate the washer, turn the knob clockwise when the wiper is operating.

PULL AND ACTUATE



IN817

Instruments and Controls

HORN

Sound the horn by depressing, the horn button. (For Hardtop models, one button on each steering spoke)

PARKING BRAKE LEVER

To set parking brake, pull the lever upwards. For the best brake performance, depress foot brake pedal with a foot at the same time.

To release it, pull upward and depress the push-button to free the ratchet, and then push it down until it stops.

If you drive a car while parking brake is partially engaged, brake shoes may overheat or rear brakes may be damaged.

On that account, make sure that parking brake is perfectly released when you drive a car.

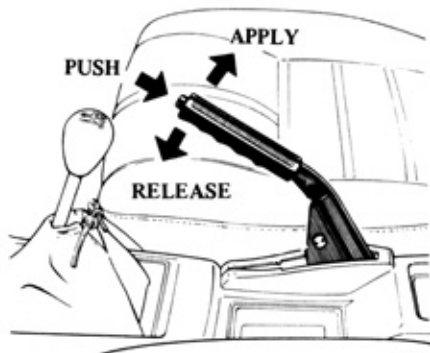

IN638

BREAK-IN SCHEDULE

All new cars require careful driving during the break-in period. Pistons, cylinder walls, and bearings must have time to seat properly and produce smooth, long wearing surfaces. Too much strain on a new engine impedes this gradual break-in process and is likely to shorten engine life.

During the first 1,600 km, do not drive at full throttle, or exceed the upper speed limit except for brief periods. However, the engine should not be allowed to labor before downshifting when climbing a hill. Variable speeds are best during the break-in period. Always drive so that the engine runs fast enough to prevent strain. After the first 1,000 km, your DATSUN should be brought to an authorized dealer for the periodic maintenance check.

Fuel economy will vary in the first few thousand kilometers of operation due to engine break-in. Also it is dependent upon driving and proper maintenance. Therefore to conserve fuel and assist the break-in:

- Do not drive at high speeds before the engine has sufficiently warmed up.
- Avoid fast starts.
- Do not allow the engine to labor in any gear.
- Avoid driving at full throttle for the first 1,600 km.
- Do not race the engine.
- Avoid extended idling periods.
- Except in an emergency, avoid heavy braking or rough usage of the brakes. This will allow the brakes to seat properly.

Starting and Operating

Break-In Speed Limit

Manual Transmission

Unit: km/h

	1st	2nd	3rd	4th	5th
4-speed	0 to 30	25 to 50	35 to 80	50 to 110	—
5-speed (Hardtop)	0 to 35	25 to 55	35 to 85	45 to 115	55 to 135

Automatic Transmission

	"1" Low	"2" Second	"D" Drive
Automatic transmission	0 to 45	35 to 80	45 to 110

STARTING THE ENGINE

~~~~~  
Warning:

Never inhale exhaust gases; they contain carbon monoxide, a colorless, odorless extremely dangerous gas which can cause death. If you should suspect that exhaust fumes are getting into the passenger compartment, have the car examined and the leakage corrected immediately.

~~~~~

1. It is not advisable to sit for any length of time in a parked car with the engine running.
2. Do not run the engine in closed spaces such as a garage for any longer than is absolutely necessary.
3. When a car has been stopped in an open area with its engine running for any significant length of time, turn the ventilator on so as to force outside air into the car.
4. If the trunk lid is not closed while driving, exhaust gases could be inadvertently drawn into the car. Thus avoid driving at high speeds for great lengths of time with the trunk lid open.
5. Always maintain the front ventilator inlet grille free from snow, leaves or any other kind of obstruction so that the car's ventilation system will be able to function properly at all times.

Ignition switch

The 5-position ignition switch includes the steering lock device and also controls the ignition system and most of the electrical equipment:

"LOCK" Normal parking position

The ignition key can be inserted and removed at the "LOCK" position only. The steering can be locked by turning the key to the "LOCK" position, removing it, and rotating the steering wheel until the locking plunger clicks into position.

To unlock the steering, insert the key and turn it to the "OFF" position. For easier key operation when unlocking, rotate the steering wheel slightly to relieve pressure on the steering lock.

"OFF"

This position permits turning the engine off without locking the steering wheel.

"START"

This position starts the engine. After the engine has started, release the key. It will automatically return to the "ON" position.

"ACC"

This position (Accessories) allows you to use all the electrical accessories controlled by the switch.

"ON" Normal operating position

This position turns on the ignition system and electrical circuits.

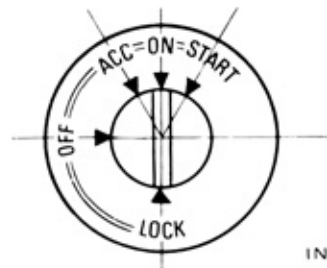

1N241

Starting and Operating

Parking

Before leaving your car:

1. Set the parking brake.
2. Place the gearshift lever in the "Reverse" (or, on the automatic transmission model, into the "P" position).

Note: When parking on an uphill grade in the manual transmission model, place the gearshift lever in the "1st" position.

3. Turn the ignition key to the "LOCK" position.
4. Remove the ignition key.
5. Lock all doors.

Before starting the engine:

- After each person is seated, close and lock all doors.
- Fasten the driver's and passenger's seat belts.
- Make sure the parking brake is "ON".
- Place the gearshift lever in "Neutral" (in "N" or "P" position for the automatic transmission).

Starting procedures for different engine conditions

NOTE:

- WITH A MANUAL TRANSMISSION, IT IS A GOOD PRACTICE TO DEPRESS THE CLUTCH PEDAL TO REDUCE DRAG FROM THE TRANSMISSION GEARS.
- AVOID PUMPING THE ACCELERATOR PEDAL OR THE ENGINE MAY BE FLOODED.
- AS SOON AS THE ENGINE STARTS RUNNING UNDER ITS OWN POWER, RELEASE THE IGNITION KEY.
- IF THE ENGINE STOPS OR FALTERS IN STARTING, WAIT 3 or 4 SECONDS BEFORE RESTARTING. THIS WILL PREVENT POSSIBLE DAMAGE TO THE STARTER OR ENGINE.

- Engine warm -

1. Depress the accelerator pedal about halfway and hold it there. Do not pump the accelerator pedal.
2. Crank the engine by turning the ignition key to "START".
3. Release the accelerator pedal as soon as the engine starts.

- Engine cold -

1. Depress the accelerator pedal to the floor and release it slowly. During cold weather where ambient temperatures are 0°C and below, fully depress and release the pedal two or three times.
2. Crank the engine without touching the accelerator pedal. If the engine starts, but fails to run, repeat the above procedure.
3. Let the engine idle for about 30 seconds after starting.
4. TAP THE ACCELERATOR PEDAL TO REDUCE THE ENGINE SPEED. The engine can then be warmed up at normal speed.

- Engine flooded -

1. Slowly depress the accelerator pedal to the floor.
2. Keeping the pedal depressed, crank the engine. If the engine still does not start, continue cranking until the engine is clear of excess fuel. Do not pump the accelerator pedal.
3. When the engine starts, release the pedal gradually as the engine speeds up.

DRIVING WITH MANUAL TRANSMISSION

Your car has a 4-forward and 1-reverse (a 5-forward and 1-reverse) speed transmission. The shift pattern diagram is shown in the figures below.

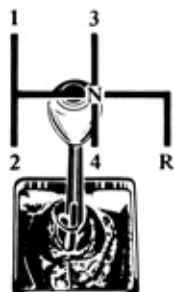

OP045



OP067

BACK-UP BUZZER (5-speed transmission models only)

The back-up buzzer sounds to warn the driver that the car is in reverse gear.

Before starting the engine, make sure that the gearshift lever is in the "N" (Neutral) position.

To start the car moving, first depress the clutch pedal fully and shift the gearshift lever from "N" (Neutral) to "1" (Low gear). Then release the clutch pedal gradually with the accelerator pedal slightly depressed.

Accelerate until the car attains enough speed to up-shift into "2" (Second gear). With the clutch pedal fully depressed, shift into "2" (Second gear), release the clutch pedal and accelerate. Shift from second to third, to fourth and to fifth in the following prescribed speed ranges, in the same manner as shifting into "2". To stop the car, release the accelerator pedal and press the brake pedal until the car slows down to 15 to 25 km/h. Then depress the clutch pedal, continuing to brake until the car stops completely.

Starting and Operating

Notes:

1. When shifting from one gear to another, be sure that you depress the clutch pedal all the way to the floor to avoid clashing and chipping the transmission gear.
2. Shift into reverse gear only after the car has completely stopped.
3. Do not rest your foot on the clutch pedal except when you are ready to shift gears. Using the clutch pedal as a footrest may result in clutch damage.
4. Never slip the clutch by releasing the pedal just enough to hold the car at a standstill on a steep hill.
5. When climbing steep grades, down-shift into a lower gear before the engine starts to labor. To maintain safe speeds on steep down-grade and to help save brakes, shift to a lower gear before you start down.
6. When quick acceleration is required, shift to a lower gear and accelerate until the car reaches maximum speed in each gear. Do not exceed the speed limit of any gear.
7. In normal acceleration, it is most economical to change gears at the lower end of the speed ranges prescribed.

Starting and Operating

Appropriate Speed Range in Each Gear

Unit: km/h

	Hardtop	Sedan and Station Wagon
1st	0 to 50	0 to 50
2nd	20 to 85	20 to 80
3rd	35 to 130	30 to 120
4th	More than 45	More than 40
5th	More than 55	—

DRIVING WITH AUTOMATIC TRANSMISSION

Cars equipped with an automatic transmission have two pedals, one for braking and the other for accelerating. The automatic transmission eliminates the clutch pedal, providing fully automatic operation for selecting and shifting gears.

How to operate selector lever

Type: 3N71B or Type: BW35

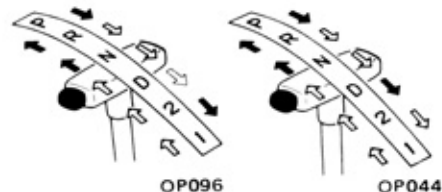

— Floor shift —

Push the button located on the end of the selector lever on when engaging “R” and “P” and when shifting from “2” to “1” or “D” to “2”, as indicated by the arrow “➡”.

The lever can be shifted freely into any of positions indicated by the arrow “↔”.

Starting and Operating

Notes:

- Start the engine in the "P" or "N" position.
- Always apply the parking brake or foot brake before shifting into any driving position. This prevents the car from creeping.
- Keep the engine at idling speed while shifting from "N" to any driving position.
- Do not accelerate to keep the car halted on a steep hill.

"P" Parking:

After parking the car, apply the parking brake and set the selector lever in the "P" position. This position locks the transmission and rear wheels. **Do not shift into "P" while the car is moving.**

"R" Reverse:

Shift into the "R" position only after the car has completely stopped. Then gently depress the accelerator pedal to back up.

"N" Neutral:

In the "N" position neither forward or reverse gear is engaged.

"D" Normal drive position:

This position is used for most city and highway driving. Press the accelerator pedal slowly to start the car and increase car speed. The 3-forward gears are up-shifted automatically from low to second and to third. When speed decreases, down-shifting is also automatic.

"2" Second gear:

Use the "2" position when starting on slippery roads or ascending hills and for effective engine braking on downhill grades.

Do not down-shift into the "2" position at speeds over 105 km/h. Do not exceed 105 km/h in the "2" position.

"1" First gear:

The "1" low gear is helpful for driving up very steep hills and for braking the car on downhill roads. When down-shifting into the "1" position, move the selector lever from "D" to "2" and then to "1".

Even if the selector lever is down-shifted into "1", the car remains in second gear until the car speed drops below 40 km/h. **Do not shift into the "1" position at speeds over 105 km/h. Do not exceed 60 km/h in the "1" position.**

Accelerator downshift

– In "D" position –

You can get extra power and acceleration for rapid passing or hill climbing by flooring the accelerator pedal to down-shift the gears. The accelerator down-shift makes the transmission down-shift into second gear when driving below 85 km/h and into low gear when driving below 40 km/h.

Starting and Operating

TIPS ON DRIVING

Economical driving

Operational economy is one of the outstanding features of your car. However, by paying attention to the following points even greater economy will result.

1. Do not pump the accelerator. Gently depress until the desired speed has been attained and then, try to maintain that speed.
2. Always drive the car in the gear which properly suits the driving conditions.
3. Maintain moderate speeds on the highway. Speeds above 80 km/h will considerably increase gasoline consumption.
4. Maintain a safe distance behind other cars. Avoid sudden stops. This will reduce wear on brake linings and pads and fuel as extra gasoline is required to accelerate back to driving speed.
5. Excessive engine idling increases gasoline consumption. If you are held up in traffic and are faced with a wait of more than a few minutes, switch off, conserve gasoline and

start up again later.

6. Keep the tires at the recommended inflation pressures for longer tire life and fuel economy.
7. Keep your engine tuned-up and follow the recommended periodic maintenance schedule. This will increase the life of all parts and lower operating costs.
8. Check your tires regularly for abnormal wear. Out of alignment wheels cause the tires to drag resulting in premature tire wear and additional gasoline consumption.

If you follow the guidelines enumerated above, you will attain remarkable savings.

Driving uphill

When starting on a steep grade it is sometimes difficult to operate the brake and clutch. The operation of the parking brake, clutch pedal and accelerator pedal is very important.

The engine brake is the most effective for descending hills. The gearshift lever should be placed in the lower speed position prior to descending. With the automatic transmission car, the "2" or "1" position should be selected.

Wet brakes

After washing the car or when driving under extremely wet conditions, the brake linings sometimes get wet. Gently apply the brakes several times as the car is moving slowly to dry the linings. Do not drive the car at high speeds until the brakes are functioning correctly.

IN COLD WEATHER

Starting off on slippery roads

When rain or snow makes the roads slippery, use caution in throttling and engaging the clutch. If the clutch is engaged too abruptly and with too much throttle, the wheels will spin and the car may not move forward. To stop the spin, back up a little. Repeatedly rolling backward and forward will get you away from the slippery patch.

In an emergency situation, the car carpet can be used as skid-matting.

Driving on slippery roads

When driving on wet or slippery roads, never brake hard. Instead, shift to a lower gear and use the braking effect of the engine.

When driving on icy roads, always proceed slowly and cautiously, turn the steering wheel gently, and use the brakes only very lightly. Moreover, al-

ways change gears smoothly, and never drive with the clutch pedal depressed.

If you should go into a skid, do not apply the brakes. Release the accelerator and turn into the direction of the skid. As the car recovers its balance, straighten out the wheels and accelerate lightly.

Tire equipment

Before starting off over icy or snow-covered roads, it is recommended that snow tires be installed on all four wheels.

Special winter equipment

It is recommended that the following items be carried in the car during winter:

1. A scraper and stiff-bristled brush to remove ice and snow from the windows.
2. A sturdy, flat board to be placed under the jack to give it firm support.
3. A shovel to dig the vehicle out of snowdrifts.

Anti-freeze

[Example]

Coolant capacity	Anti-freeze		
	1.3 liters (1 $\frac{1}{8}$ Imp qt)	2.5 liters (2 $\frac{1}{4}$ Imp qt)	3.8 liters (3 $\frac{3}{8}$ Imp qt)
7.5 liters (6 $\frac{3}{8}$ Imp qt)	-7°C	-18°C	-35°C

Starting and Operating

In the winter when the temperature is anticipated to drop below 0°C add anti-freeze solution to the cooling water.

Battery

If the correct specific gravity of the battery electrolyte is not maintained during extreme cold weather condition, the electrolyte may freeze and damage the battery. Therefore to maintain its maximum efficiency it should be checked regularly.

Draining of coolant water

If the car is to be left outside without anti-freeze, drain the coolant by opening the cocks located under the radiator and on the side of the cylinder block.

Replacing lubricant

When the temperature drops below -12°C, it is recommended that the lubricating oil be replaced with one of a lower viscosity. Refer to "Recommended SAE Viscosity Number" section.

Corrosion protection

In the winter season, streets, roads and highways are often spread with salt-based compound to melt the snow or ice.

Although this compound is very effective for this purpose, it is not good for the car. It may cause rust development and corrosion. To prevent this, we strongly recommend that before the winter season you bring your car to your authorized NISSAN/DATSUN dealer to have him check, and if necessary, repair the underside coating of the car.

IN HOT WEATHER

Replacing the lubricant

When the temperature stays over 32°C, the lubricating oil should be replaced with one of a higher viscosity.

Comfort and Convenience Features

VENTILATION SYSTEM

Flow-away outlets that act like one-way valves are provided in the rear quarter panels. When all the windows are closed, they allow air to flow out of the car but not into it, thereby providing constant and draft-free circulation.

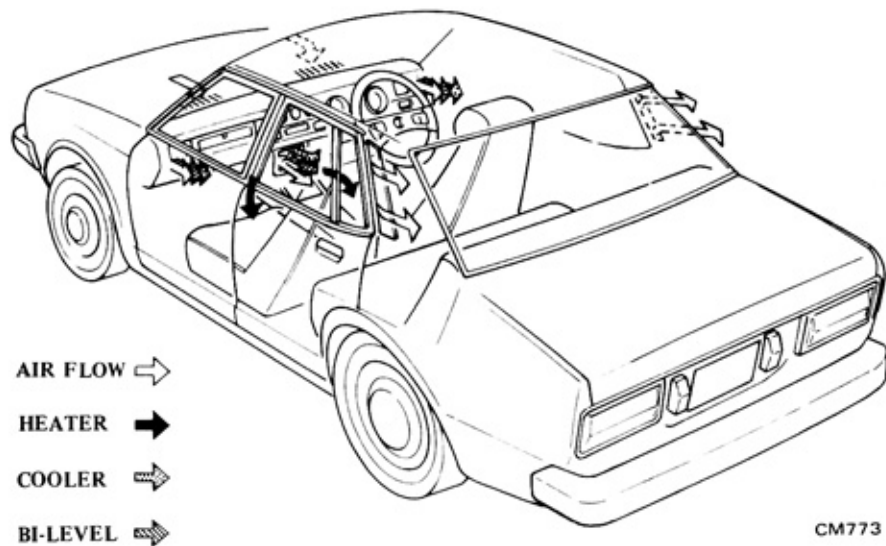

Two side ventilators on the dash enable you to ventilate the car with fresh air in any weather without opening the windows. To draw fresh air into the car, pull the knob in the outside of the ventilator.

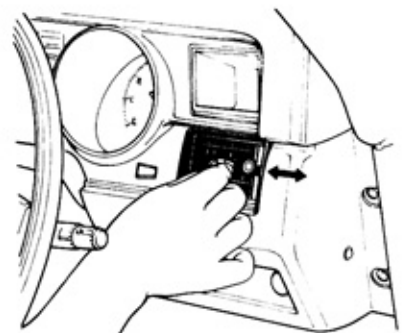

CM774

Comfort and Convenience Features

HEATER

The heater is controlled by two levers and one knob located in the middle portion of the instrument panel.

1. The "AIR" lever to select the position of airflow.
2. The "TEMP" lever to control air flow temperature.
3. The "FAN" switch knob to regulate the amount of airflow.

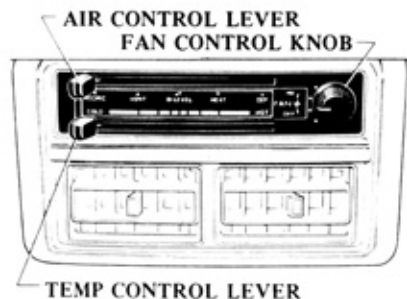

CM559

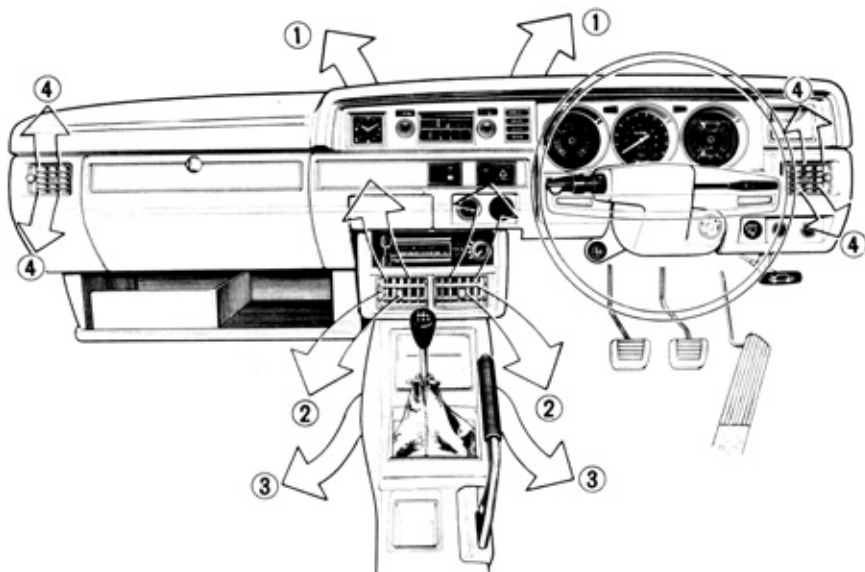

CM775

Comfort and Convenience Features

② To shut off the outside air

Move the "AIR" control lever to the "RECIRC" position and the "TEMP" control lever to the left.

Shut off the outside air while driving on dusty roads.



CM562

② To ventilate the car

Move the "AIR" control lever to the "VENT" position and the "TEMP" control lever to the desired position.



CM563

Outside air is discharged from the center outlets.

① ③ To heat the car

Move the "AIR" control lever to the "HEAT" position. Move the "TEMP" control lever to the desired position.

Move the "FAN" control knob to the desired speed position.



CM565

① ② ③ To ventilate and heat the car

Set the "AIR" control lever at the "BI-LEVEL" position, and the "TEMP" control lever at the desired position.



CM564

Outside air is discharged from the center outlets and heated air is discharged from the lower outlets.

① To defrost and defog the windshield glass

Move the "AIR" control lever to the "DEF" position and the "TEMP" control lever to the desired position. Turn the "FAN" control knob to the desired position.



CM566

Note: Numbers in the chart coincide with air vents in the figure (CM775).

Comfort and Convenience Features

Operating tips

- Clear any snow and ice from the air inlet in front of the windshield to improve heater and defroster efficiency.
- Always remove snow and ice from the front, side and rear windows to improve defogging efficiency and ensure proper visibility.
Remove snow and ice from the outside mirrors and lights at the same time.
- For adequate rear seat heating, always ensure that the areas beneath the front seats are clear, and operate the fan as required.

AIR CONDITIONER

The air conditioning system combines the functions of cooling, heating, ventilating and recirculating into one unit. The system is operated by the control levers located on the control panel on the instrument panel.

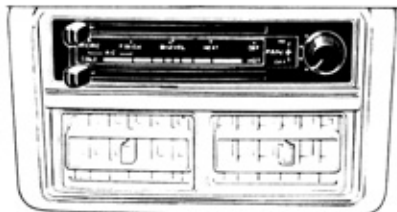

CM567

“AIR” control lever

Recirculating, heating and ventilating requirements are handled by a variety of system which can be selected by the “AIR” control lever; this lever must be set at the “A/C” position when cooling is required.

When this lever is in the “RECIRC” or “AIRCON” position, the air inside the car will be recirculated.

When this lever is in the “FRESH” position, a mixture of 40% outside air and 60% inside air is drawn into the air conditioner and directed to the interior through the three instrument panel outlets.

“TEMP” control lever

The “TEMP” control lever can be set at any position between “COLD” and “HOT” to regulate the cooling temperature to your preference.

“FAN” control knob

The fan switch has four positions. One position for “OFF” and three others control fan speed.

To cool the car

Set the “AIR” control lever at the “A/C” position.

Move the “FAN” control knob to any position other than the “OFF” position.

Comfort and Convenience Features

Move the "TEMP" control lever to any position for the desired temperature.

Cooled air is discharged into the interior through three outlets. One outlet is located in the center of the instrument panel and the other two are on either side of the instrument panel.

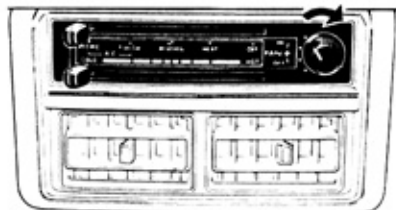

CM568

To heat the car

Bi-level

To defrost and defog the windshield

Utilize the same procedure as that for the heater.

- If the cooling system has not been used for a week or more, or if the ambient temperature range is below 15°C, the system should be run in by turning the switch on and off several times at three second intervals, with the engine running at low speed. This will add much to the service life of the system.
- If anything unusual is noted in the operation of the system, shut it off immediately and have it checked by your NISSAN/DATSUN dealer.
- It is suggested that the system be run for about ten minutes or so at least once a month in winter, so that it will be ready for use next season.
- At the start of the season have the air conditioning system checked by your NISSAN/DATSUN dealer.

Operating tips

- If your car has been parked in the sun for a period of time with all the windows closed, drive for two or three minutes with all windows open. This will allow the air conditioner to operate more quickly, when the windows are closed, as the hot air has been forced out of the car.
- If stopped in traffic during hot weather, place the automatic transmission lever in PARK "P" position to increase the engine idle speed. This helps to cool the engine and assists air conditioning efficiency.
- When cooled air is desired under normal conditions, set the lever at the "FRESH" position. If you desire more cooled air or outside air is contaminated (such as in a long tunnel or in a garage), set it at the "RECIRC" position.
- When the "RECIRC" position is used for an extended period of time, place the lever in the "FRESH" position now and then to take in outside air.
- When smoking a cigar or cigarette with the air conditioner in operation, open the window approximately 5 mm (¼ in).

Comfort and Convenience Features

REAR WINDOW ELECTRIC DEFROSTER SWITCH (Except Standard Deluxe)

An electric defroster is built into the rear window.

To heat the rear window glass, move the switch to the "ON" position. (A warning light will glow to indicate the system is on.)

When the window is clear, turn the switch off.

The switch operates only when the ignition switch is "ON".

Note: When you clean the car, do not clean the inner side of the window with abrasive-type cleaners, and do not use any type of scraper to remove foreign deposits from the inner glass surface.

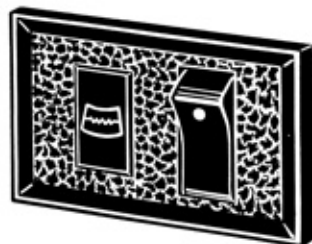

IN393

RADIO

The radio has five push buttons for station selection. Other stations may be selected by the manual tuning knob.

The ignition key must be in the "ON" or "ACC" position.

AM (MW) radio

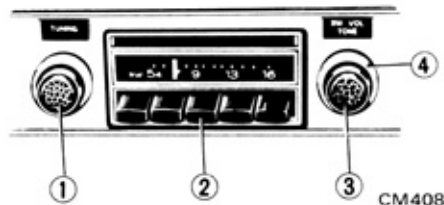

- ① Manual tuning control knob
- ② Tuning push buttons
- ③ On-Off volume control knob
- ④ Tone control (outside knob)

AM/FM radio

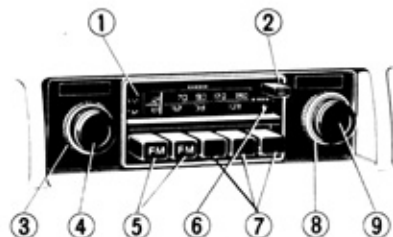

- ① AM/FM indicator
- ② Stereo/monaural and speaker changeover button
- ③ Balance control (outer side knob)
- ④ Manual tuning control (inner side knob)
Turn the knob to move the slide bar from side to side
- ⑤ FM selector button
- ⑥ Stereo indicator
- ⑦ AM selector button
- ⑧ Tone control (outer side knob)
- ⑨ ON-OFF switch and volume control (inner side knob)

Comfort and Convenience Features

Setting push buttons

1. Pull the selector button straight out until it stops. Tune in the station you want with the manual tuning knob at the left side of the radio dial.
2. After the station is clearly tuned in, push the selector button straight in until it stops, then release it.
3. Repeat steps 1 and 2 for the remaining station selector buttons.

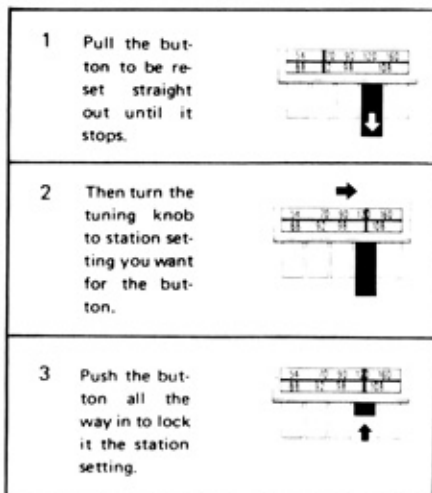

CM786

STEREO TAPE PLAYER

Cassette type

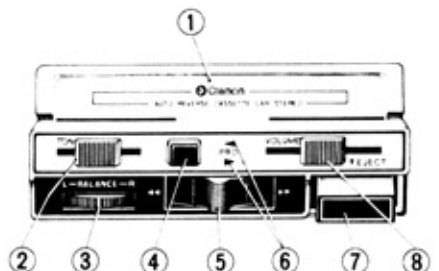

CM576

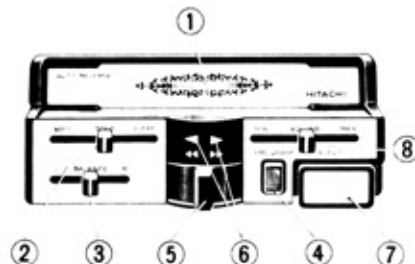

CM578

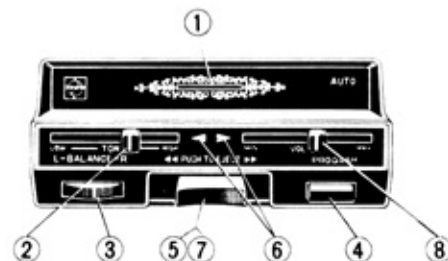

CM577

- ① Lid (Tape door)
- ② Tone controller
- ③ Speaker balance controller
- ④ Program select button
- ⑤ Fast forward-rewind knob
- ⑥ Channel indicator
- ⑦ Eject button
- ⑧ Volume controller

Comfort and Convenience Features

Turn the ignition key to the "ON" or "ACC" position and insert the tape cassette gently through the tape door as far as it will go. The tape channel indicator will come on and the music will start. The tape cassette contains two programs, which are automatically played in succession.

- To select a program, push the program select button.
- To stop, push the eject button.
- Move the speaker balance control knob until volume from right and left speakers are balanced.
- To rapidly select a particular program, move the fast forward-rewind knob in the direction desired. The knob remains locked and should be returned to the original (neutral) position after the desired program is reached.

Notes:

- a) When the car has been parked in a hot or humid place, run the car for some distance before starting the stereo tape.
- b) Store the tape in a cool, clean and dry place in the shade, with the tape end of the cassette (cartridge) in an upright position.

- c) Pull the cassette (cartridge) out when it is not in use. [If the cassette (cartridge) is left in place for a long time, with the electrical power switched off, the roller will be deformed and will start to rotate irregularly.]

Cleaning: After being used for a long time, the head of the cassette (cartridge) will be covered with dust and tape powder.

This residue may serve to deteriorate the quality and output of the tape.

Push open the tape door and clean the capstan (revolving metal post), head and tape guide with alcohol (do not use carbon tetrachloride).

CLOCK

Sedan:

Second hand

Reset to zero by pushing the knob in slightly and turning it.

Minute hand

Reset by pushing the knob in fully and turning it.

Hardtop:

Second hand

Reset to zero by pulling out the knob.

Minute hand

Reset by pulling out the knob and turning it.

Station Wagon:

Reset by pulling out the knob and turning it.

CIGARETTE LIGHTER

The cigarette lighter is located on the instrument panel face. To operate it, push it in. When it becomes heated, it automatically pops out ready for use.

The illumination light equipped into the cigarette lighter socket lights for you to locate easily at night.



CM221

Comfort and Convenience Features

ASH TRAYS

The ash trays are located on the instrument panel and on the wall of both rear doors or on the upper face of both rear arm-rests. To remove the ash tray from the instrument panel or on the wall of doors for cleaning, press down on the tab and pull the ash tray out. To remove the rear arm-rest ash tray, only lift it out.

To install the instrument ash tray, position the tray to opening and push in. To install the rear door ash tray, position the tray to opening, bottom first, and push in.



CM262

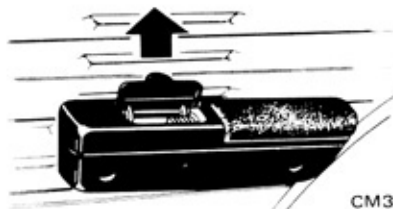

CM328



CM151

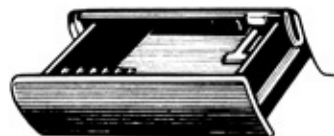

CM776

ROOM LIGHT (Interior light)

To turn on the room light, flip the switch knob to the "ON" position. To turn off the room light, flip the switch knob to the "OFF" position. When the switch knob is in the "DOOR" position, the room light can be turned on and off automatically by opening and closing the driver or passenger door.

LUGGAGE COMPARTMENT LIGHT

Station Wagon

To turn on the room light, flip the switch knob to the left position. When the knob is in the right position, the room light will be turned on and off automatically by opening and closing the tailgate.

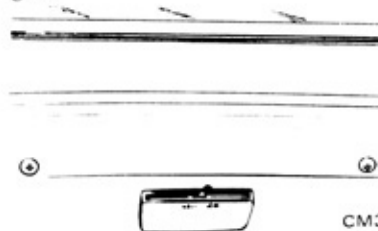

CM374

Comfort and Convenience Features

SUN VISOR

As the fitting shaft is pivoted, the sun visor also moves sideways.

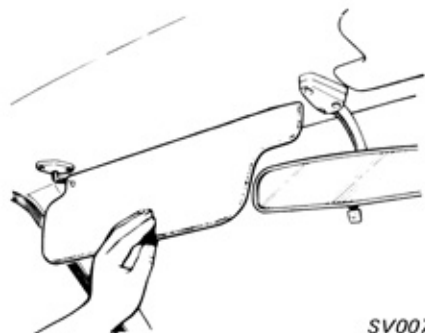

SV007

ASSIST GRIPS AND COAT HANGERS

An assist grip with the coat hanger is attached to the door arm-rest or the roof rail above the side window.

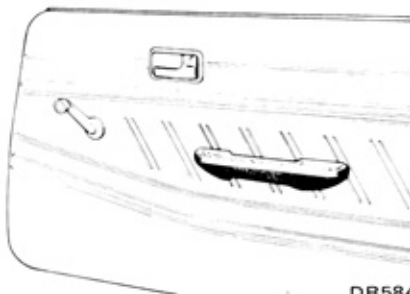

DR584

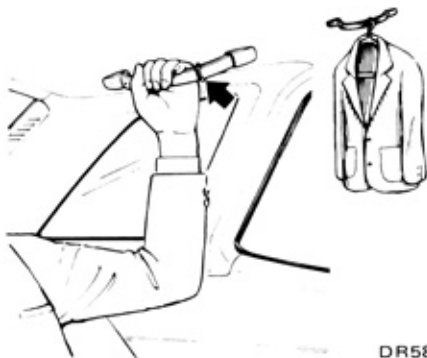

DR585

Note: Do not hang anything on the assist grip in such a manner that the driver's view is obstructed.

COIN HOLDER

A coin holder is provided at the end ledge of the instrument panel.

A hollowed-out receptacle for holding stacks of coins (see illustration), it serves for your small change convenience at toll gates and others.



DR688

Comfort and Convenience Features

WINDOW CONTROL

Rotate the window control handle to raise or lower the window to any desired position.



CM267

CONSOLE BOX

The console box is situated between the driver and the assistant seats.



DR587

GLOVE BOX LOCK

To open the lid, insert the key and turn it clockwise. To lock, turn it counterclockwise.

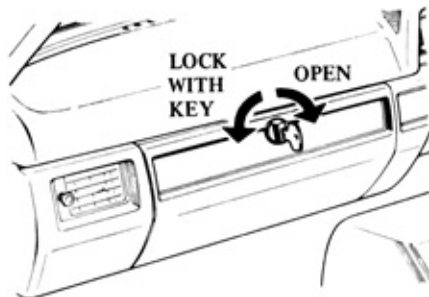

DR689

TRUNK LID LOCK

Sedan and Hardtop

To open the trunk lid, insert the key and turn it clockwise.

To close, just push the lid firmly. With the trunk lid open, the trunk room light glows.

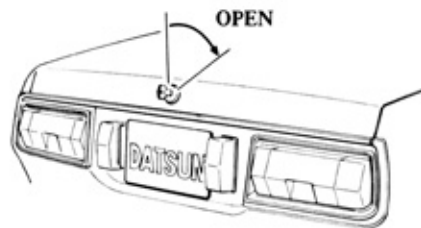

CM816

TRUNK LID OPENER

Sedan and Hardtop

To open the trunk lid, pull up the control lever. To lock, push the trunk lid down securely. No further key operation is required.

Comfort and Convenience Features

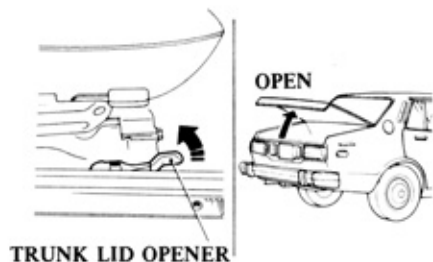

TRUNK LID OPENER

TL017



DR249



DR225

TAILGATE LOCK

Station Wagon

To open the tailgate, insert the key and turn it counterclockwise. Then push the latch button in.

To lock, insert the key and turn it clockwise.

If the tailgate is unlocked, push the button to open the gate.

Caution: Be careful not to hit any part of your body on the tailgate when it is open.

FOLDING REAR SEAT (Station Wagon)

The rear seat of your Station Wagon may be quickly and easily converted into cargo space when needed.

Pull the pulling strap of the rear seat cushion and fold down the seat cushion.

Release seatback lock and pull the seatback forward and down to make the floor into the cargo space.

Be sure that the locking rod of the seat cushion is inserted in the hole at the side of the seat back.

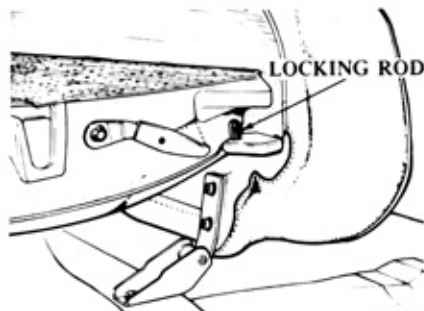

DR226

In Case of Emergency

HAZARD WARNING FLASHER

Use the hazard warning flasher to warn other drivers that your car is disabled or parked under emergency conditions. Pull off the roadway if possible.

FREEING IMMOBILIZED CAR

In the case where the drive wheel(s) get stuck in sand, mud, snow, ice, etc., it is necessary to rock the car to get free. At that time, you should move the gear shift lever from first to reverse in a repeat pattern while simultaneously depressing the accelerator gently. (On automatic transmission models, operate the selector lever from "D" to "R" position.)

If the car is not freed by the above procedures, anti-skid materials should be placed under the spinning wheel(s) or the car should be towed out.

Under such circumstances, avoid facing the engine. This is because one actual drive wheel spins at twice the speedometer reading when the other drive wheel is stopped resulting in tire and differential damage.

TOWING THE CAR

If it becomes necessary to tow the car, connect a rope to the towing hook as illustrated. Before towing, release the parking brake and place the transmission in neutral ("N" for automatic transmission).

Be sure that the transmission and rear axle are in proper working order before towing.

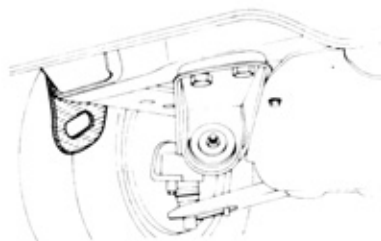

WH168

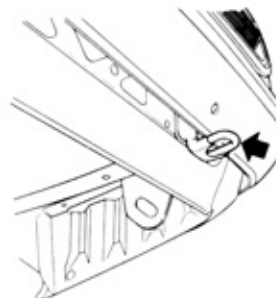

WH225

Hardtop and Sedan

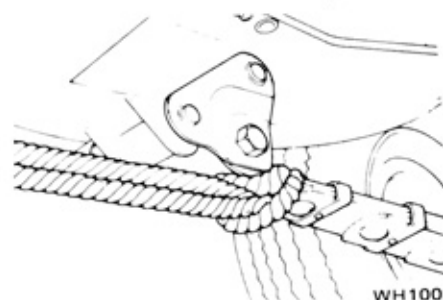

WH100

Station Wagon

In Case of Emergency

If a car with an automatic transmission is being towed on its rear wheels, do not exceed 30 km/h and do not tow farther than 10 km.

If the transmission is inoperative, tow the car with the rear wheels off the ground, or with the propeller shaft removed.

Notes:

- a) Towing rope should not be connected to any positions except those described above.
- b) Do not take up slack in the rope too quickly.
- c) Always pull the rope in a straight direction with respect to the hook. Do not apply force to the hook in side direction.

Caution: When the car is towed with the rear wheels raised, the steering wheel should be secured to maintain a straight ahead position.

PUSH STARTING

With manual transmission

If you cannot start your engine in the normal manner, it can be started by pushing.

As the push begins, turn the ignition to "ON", place the shift lever in second or third gear, and keep your foot all the way down on the clutch pedal. Hold the accelerator pedal about halfway down. When the car reaches a speed of about 16 km/h, slowly release the clutch pedal to start the engine.

CAUTION:

NEVER TRY TO START THE CAR BY TOWING IT; WHEN THE ENGINE STARTS, THE FORWARD SURGE COULD CAUSE THE CAR TO COLLIDE WITH THE TOW VEHICLE.

With automatic transmission

Cars equipped with automatic transmissions cannot be started by pushing.

JUMP STARTING WITH BOOSTER BATTERY

Because explosive hydrogen gas is always present in the vicinity of the battery, keep all sparks and flames away from it.

Do not, under any circumstances, allow battery fluid to come into contact with eyes, skin, cloth or painted surfaces. Battery fluid is a corrosive sulphuric acid solution which can cause severe burns. If the fluid should come into contact with anything, immediately flush any contacted area with water.

If done incorrectly jump starting can be hazardous.

Always follow the below instructions.

1. Position the two cars in such a manner that their engine compartments are in close proximity to each other. Set parking brakes. On manual transmission models set the gear lever in "neutral"; on automatic transmission models set the lever in "park". Switch off all unnecessary electrical systems (lights, heater, etc.).

Caution:

Ensure that the battery of the other vehicle is a 12-volt, negatively grounded one.

2. Run one jumper cable from the positive terminal of the booster battery to the positive terminal of the discharged battery. Run the other cable from the negative terminal of the booster battery to the negative terminal of the discharged battery.

Caution:

Never confuse these jumper cable connections. If connections deviate from that described in the foregoing, damage to both charging systems or even serious personal injury could result.

3. Run the other car's engine at a steady 2,000 rpm or so, and then start your engine in the usual manner.
4. Once you have your engine running, carefully disconnect the jumper cables, exactly reversing the connection procedure.

Maintenance

OPENING THE HOOD

To unlock, pull the hood lock handle located below the instrument panel.

To open the hood, release the safety catch located under the center edge of the hood and raise the hood. To keep the hood opened, insert the stay in the hole of the hood and before shutting the hood, fasten the stay to the clamp firmly. To close the hood, lower and push it down firmly.

It locks automatically.

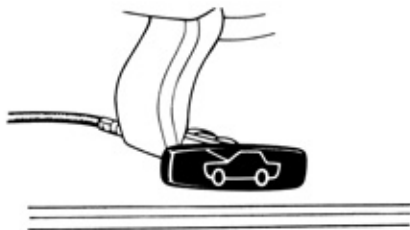

CM188

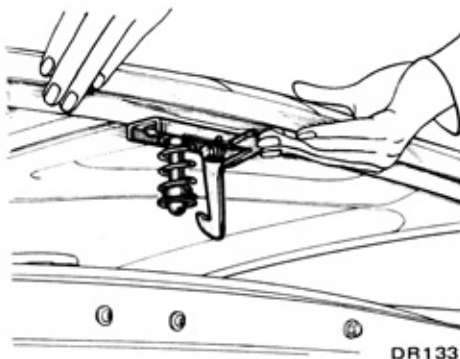

Caution: Pull up on the hood edge to be sure that it is closed securely.

ROUTINE SERVICE

The following items should be checked daily and/or weekly, or whenever you refuel.

- Engine oil level
- Engine coolant level
- Brake and clutch fluid level
- Windshield/Rear window washer fluid level
- Battery electrolyte level
- Tire inflation pressure

Engine oil level

The engine oil should be maintained at the correct level. The best time to check it is before operating the engine. This will allow oil accumulated in the engine to drain back into the crankcase.

To make an accurate oil level check;

- Park the car on a level surface.
- Remove the dipstick and wipe it clean.
- Reinsert it all the way into the tube for an accurate reading.
- Remove the dipstick and check the oil level. It should be between the "H" and "L" marks.
- After taking the reading, reinsert the dipstick.

If the oil level is at or below the "L" mark, add sufficient oil into the oil filler, located on the cylinder head cover, to raise the level to the "H" mark. Do not overfill.

It is not abnormal to add some oil between oil changes or during the break-in period, depending on the severity of operating conditions.

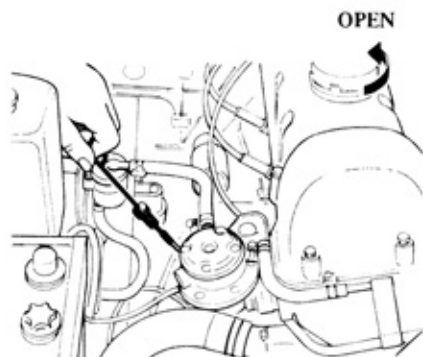

DA292



DA097

Engine coolant level

Regularly check the amount of coolant in the radiator when the engine is cold. If it is found to be insufficient, add coolant up to the specified level. If it becomes necessary to add coolant with excessive frequency, your cooling system should be inspected by your NISSAN/DATSUN dealer or other competent service facility.

Warning: Never remove the radiator cap when the engine is hot; serious burns could be caused by high pressure fluid escaping from the radiator.

Carefully remove the cap by turning it a quarter turn to allow built-up pressure to escape and then turn the cap all the way off.

20 to 40 mm ($\frac{3}{4}$ to 1 $\frac{1}{2}$ in)

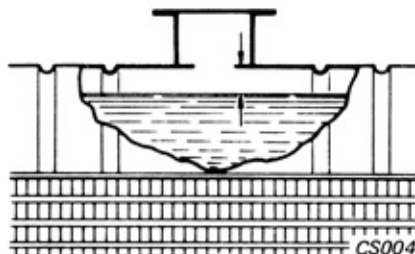

CS004

Brake and clutch fluid level (Hardtop and Station Wagon)

To check the fluid level, turn the reservoir cap outer ring counterclockwise and pull it upwards.

Fluid level should be maintained at the level marked on each reservoir. If the fluid level falls considerably below this level, the brake system should be thoroughly checked by your authorized NISSAN/DATSUN dealer.



DA120

Maintenance

Brake fluid level (Sedan)

To add fluid, lift off the reservoir cover.

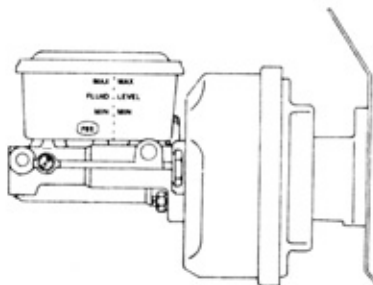

Windshield/Rear window washer fluid level

Front

Check the fluid level in the reservoir and add fluid if necessary. Use a windshield washer fluid. Do not operate the washer switch when the reservoir is empty.

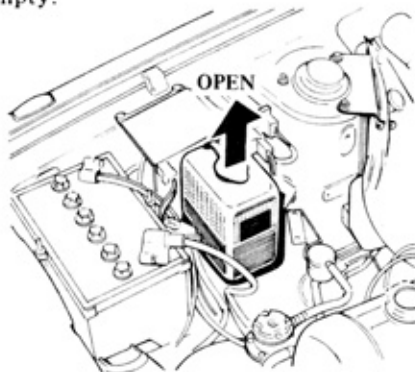

DA294

Rear (Station Wagon)

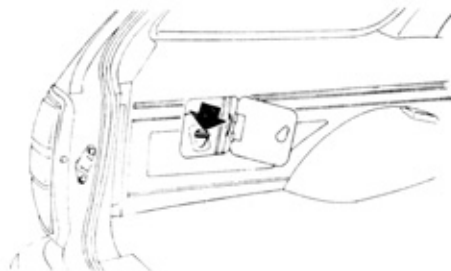

DA243

Battery electrolyte level

Check the fluid level in each filler. If necessary, add only distilled water to bring the level to the indicator in each filler opening. Do not overfill.

The battery surface should be clean and dry. Periodically apply a small amount of grease to each terminal to prevent corrosion.



DA279

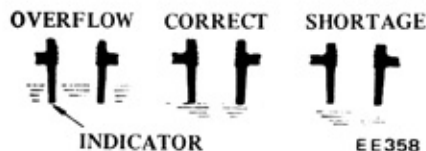

Caution: Do not expose the battery to flames or electrical sparks. Hydrogen gas generated by battery action is explosive. Do not allow battery fluid to come in contact with skin, eyes, fabrics, or painted surfaces. If the acid contacts the eyes, skin or clothing, immediately flush with water for 15 minutes and seek medical attention. In freezing weather, run the engine for a while after adding distilled water, to make sure that the water mixes properly with the fluid. Otherwise the water may freeze and damage the battery.

Tire inflation pressures

Check tire inflation pressures and maintain them at the pressures shown on the tire plate affixed to your car or

listed in the following chart. Improper tire pressure can adversely affect tire life, riding comfort and load carrying capacity.

Unit: psi (kPa)

RECOMMENDED COLD TIRE INFLATION PRESSURE				
Tire size	Normal load		Maximum load	
	Under 70 MPH (110 km/h)	Over 70 MPH (110 km/h)	Under 70 MPH (110 km/h)	Over 70 MPH (110 km/h)
165SR14 185/70HR14	28 (193)	28 (193)	28 (193)	28 (193)
6.45S14	Front	24 (165)	28 (193)	28 (193)
	Rear	24 (165)	28 (193)	28 (193)

NOTE: Inflation pressure should be measured when the tire is cold.

Maintenance

OIL AND FUEL RECOMMENDATION

Fuel recommendation

Your DATSUN is designed to operate on a good quality of gasoline with a minimum octane rating of 88, which is rated by the research method.

Using a fuel with too low an octane rating will result in "spark knock". Continuous or excessive "spark knock" may result in engine damage.

If "spark knock" occurs, change to the next higher grade of fuel or consult your designated NISSAN/DATSUN dealer.

Engine oil recommendation

Use only the engine oil listed in the Recommended Lubricants. Change engine oil at the intervals recommended in the "Periodic Maintenance and Lubrication Schedule". It should be noted that oil change intervals longer than those listed above will seriously reduce engine life.

Operation under the following conditions may require more frequent oil changes.

- short distance driving at cold outside temperatures,
- driving in dusty conditions,
- driving for long distances,
- towing trailers.

Recommended engine oil viscosity

The proper oil viscosity for your engine should be determined by the average outside temperature to assure good cold and hot starting.

Select the proper oil viscosity from the following chart:

Recommended SAE viscosity number

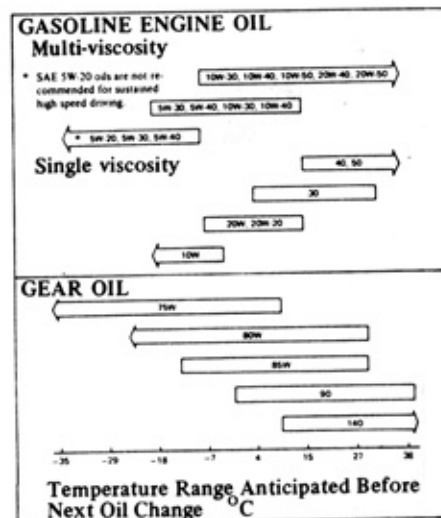

Recommended lubricants

Item		Specifications	Remarks
Engine oil	Gasoline	SAE Classification SD or SE (MIL-L-2104B)	Refer to Recommended SAE Viscosity Chart
Gear oil	Transmission and Steering	API GL-4 (MIL-L-2105)	
	Differential	API GL-5 (MIL-L-2105B)	
Automatic T/M		Type DEXRON	———
Multi-purpose grease		N.L.G.I. 2	Lithium soap base
Brake and Clutch fluid		DOT 3 (F.M.V.S.S. No. 116)	F.M.V.S.S.: Federal Motor Vehicle Safety Standard
Anti-freeze		———	Permanent anti-freeze (Ethylene glycol base)

Maintenance

MINOR MAINTENANCE

The following are the minor checks that you can make periodically. If any deficiencies are found, regarding the need for repairs or replacements, your car should be brought to the attention of your authorized dealer or service station.

Hood lock

Check the hood to see if it is closed and locked properly. Lubricate the hood lock assembly periodically.

Apply grease to all functioning parts after wiping off any accumulation of dirt on lock parts.

Ensure that the lock and release mechanisms work smoothly by operating several times.

Automatic transmission fluid

Check the fluid level at the intervals recommended in the "Periodic Maintenance and Lubrication Schedule". To make an accurate fluid level check:

1. Drive car several kilometers to bring transmission up to normal operating temperature.
(Approximately 50 to 80°C)
2. Park the car on a level surface and apply the parking brake.
3. Place select lever in park "P" position and leave engine running.
4. Remove dipstick and wipe it clean.
5. Reinsert dipstick all the way into the filling pipe.
6. Remove dipstick and note reading.

If fluid level is at or below the "L" mark, add enough fluid to raise the level to the "H" mark. Do not overfill. See "Recommended Lubricants" for fluid.

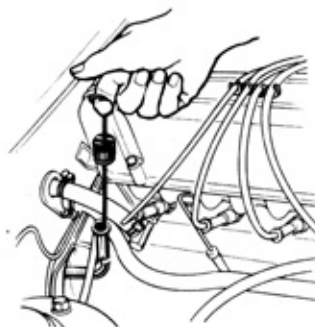

DA140

MI056

Cooling fan belt

Inspect the fan belt for wear, fraying, and cracking at the recommended intervals. If the belt is in poor condition, replace it. Check the fan belt tension frequently by applying moderate thumb pressure midway between the alternator and water pump pulley.

The belt should deflect 8 to 12 mm (0.31 to 0.47 in). Tighten a loose belt by moving the alternator up or down.

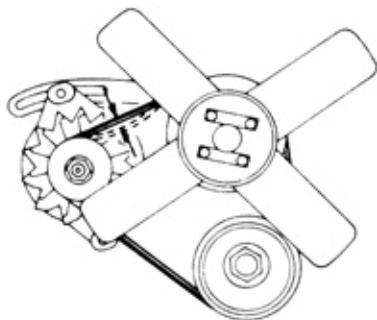

DA141

Engine cooling system

The cooling system has been filled at the factory (Hardtop and Station Wagon only) with a solution of Long Life Coolant (L.L.C.) and water for all season protection. This coolant provides protection to -35°C in a ratio of 50% Long Life Coolant while protecting the engine against corrosion.

It is necessary to replace the coolant periodically as recommended in the "Periodic Maintenance and Lubrication Schedule" section.

Air cleaner element

The coated paper element need not be cleaned.

Change the element periodically as recommended in the "Periodic Maintenance and Lubrication Schedule" section. Operation under dusty conditions may require more frequent element changes.

Oil filter

The oil filter should be changed periodically. Proper oil filtration is just as essential as the use of good engine oil.

The oil filter is a cartridge type. It must be renewed periodically as recommended in the "Periodic Maintenance and Lubrication Schedule".

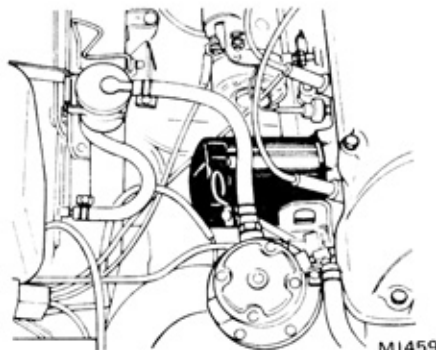

MI459

Maintenance

Spark plugs

The spark plugs should be checked periodically as recommended in the "Periodic Maintenance and Lubrication Schedule". Remove spark plugs and inspect for the deposits and the degree of electrode erosion to ascertain the condition of combustion. Light brown or gray deposits on firing tips indicate good combustion.

After cleaning carefully, adjust the spark plug gap. The gap should be 1.0 to 1.1 mm (0.039 to 0.043 in). Since the plugs will not last forever, replace periodically even if they look good.

Note: A label is attached to the rocker cover if your engine is equipped with resistor built-in type spark plugs. Whenever spark plugs are replaced, make sure that they are of the same type and rating.



Distributor breaker point

Breaker points and gap should be inspected periodically as recommended in the "Periodic Maintenance and Lubrication Schedule".

Be sure that the contact surfaces are clean and not so burned as to require replacement. The correct gap of 0.45 to 0.55 mm (0.018 to 0.022 in) should be checked with a feeler gauge.



Windshield wiper blades

Check the wiper blades for operation and cleanliness. If the wiper blades do not wipe the windshield clean after the blades and windshield have been wiped off with a cloth, replace the blades.

To adjust the washer spray, move the nozzles toward the center of each half of the windshield.

Steering wheel

With the steering wheel in the straight ahead position, measure the amount of steering wheel play. Turn the steering wheel in both directions within the range where the front tires remain stationary as seen with the eyes; the amount of circumferential movement of the steering wheel at this time is the steering wheel play.

If the play exceeds 35 mm (1.38 in), have the steering wheel adjusted by your authorized NISSAN/DATSUN dealer.

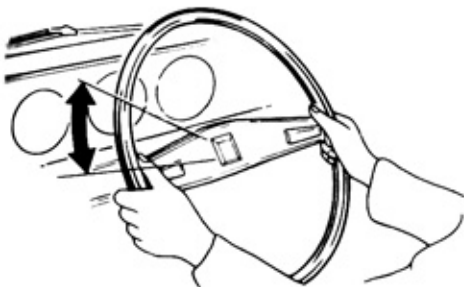

DA241

Brake pedal

When the brake pedal is fully depressed, the distance between the upper surface of the pedal pad and floor board should be 75 mm (2.95 in) or more.

When this distance approaches the prescribed limit value, have the brake adjusted by your authorized NISSAN/DATSUN dealer.

If the distance should abruptly be shortened, there is something wrong with the brake system. Stop driving your car immediately.

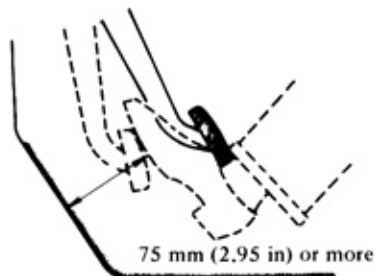

M1347

Clutch pedal

The clutch pedal should not encounter resistance during the first 1 to 5 mm (0.04 to 0.20 in) of its stroke. Resistance should then be felt by the foot riding on the clutch pedal. If the pedal stroke is out of adjustment, have the clutch adjusted by your authorized NISSAN/DATSUN dealer.

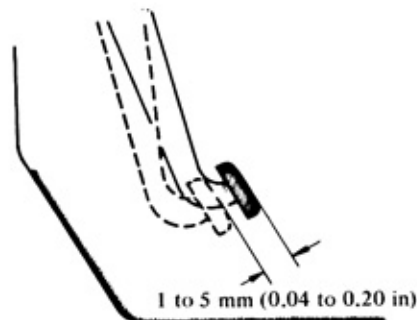

M1348

Maintenance

Parking brake

From the completely released position, apply the parking brake slowly and firmly, counting the clicks. If the number of clicks is 5 to 6, the parking brake is in good condition. If the number is excessive, have the parking brake adjusted by your authorized NISSAN/DATSUN dealer.



Fuses

Fuses are located under the right side of the instrument panel.

If a fuse needs to be replaced, refer to the specifications listed on the fuse box cover.

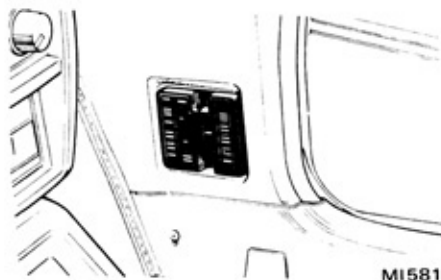

Bulb specifications

Light	Bulb
Headlight	
Inner	37.5W
Outer	37.5/50W
Turn signal light	21W
Parking light	5W
Side flasher	5W
Tail/Stop light	5/21W
Back-up light	21W
License plate light	5W
Room light	10W
Trunk compartment light	5W
Luggage compartment light (Station Wagon)	10W
Instrument illumination light and indicator lights	3.4W

Bulb replacement

The replacement of each bulb is performed in the following manner. If the new bulb that has replaced the old one does not come on, get your NISSAN/DATSUN dealer to check it.

Before replacing the bulb, disconnect the battery ground cable.

Headlight

1. Remove the bolts attaching the headlight finisher, and pry off then remove the headlight finisher.

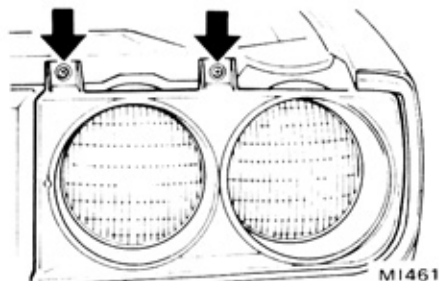

2. Loosen the three screws which hold the headlight retaining ring. Turn this ring clockwise, and take off the headlight when it fits in with the large hole in the ring.

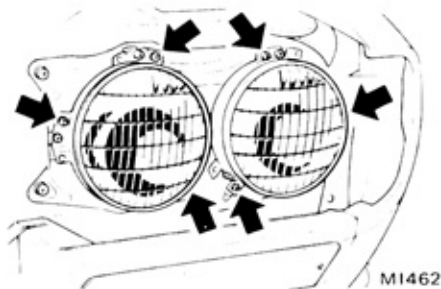

Note: Be careful not to disturb the aiming adjusting screws.

3. After removing the headlight from the mounting ring, remove the wiring connector from the rear end of the bulb.
4. Semi-sealed beam type
Detach the boot mounted around the beam connector. Remove the bulb with the socket by rotating the socket counterclockwise.

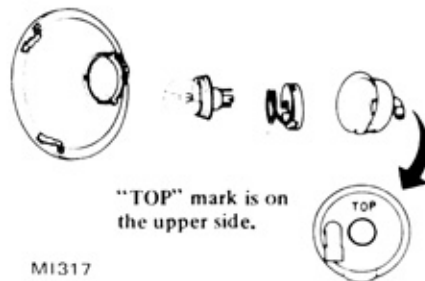

"TOP" mark is on the upper side.

5. The new bulb should be installed in the reverse sequence of removal. In installing the new bulb, be sure that the "TOP" raised on the lens is on the upper side. When aiming adjustment is necessary, see your NISSAN/DATSUN dealer.

Front combination light

To replace the clearance-turn signal light, remove the screws retaining the lens, and replace the bulb with a new one.

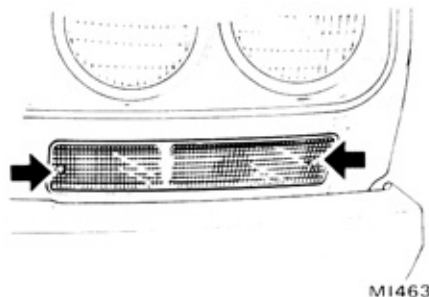

Maintenance

Side marker light

To replace the front side marker light, remove the screws attaching the lens, take off the lens, and replace the bulb with a new one.

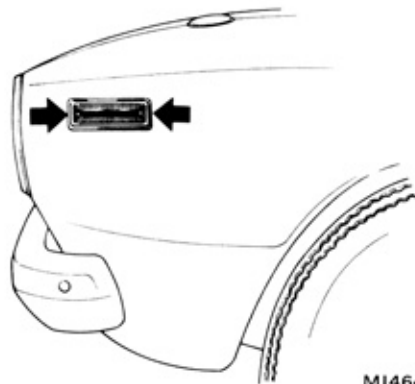

MI464

Rear combination light

Sedan and Hardtop: In replacing the turn signal, stop, tail and back-up lights, open the trunk lid, remove the two setting screws, withdraw lamp body, and take out the bulb. Then install a new bulb.

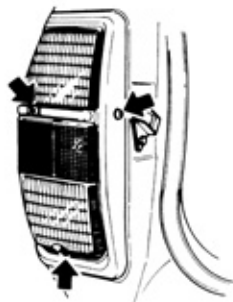

MI466

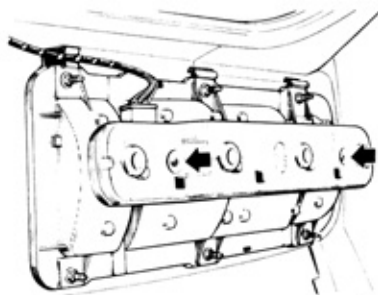

MI465

Station Wagon: Replacing the stop, tail, back-up or turn signal lights, remove the screws attaching the lens housing, turn the bulb socket counterclockwise, and take the bulb out from the housing. Then install a new bulb.

License plate light

Station Wagon

To replace the license plate light, remove the screw attaching the lens, and replace the bulb.



MI248

Sedan and Hardtop

To replace the license plate light, disconnect the socket, and replace the bulb.



CM817

WHEEL AND TIRE

Tire care

Tires have tread wear indicators in the surface. When the indicators appear, the tire should be replaced. When replacing tires or wheels, use the standard or optional tire sizes and types recommended on the tire plates affixed to the car or listed in the "Tire inflation pressures". Tires and wheels other than those recommended can adversely affect the ride, handling, ground clearance, body-to-tire clearance, and speedometer calibration.

Interior light

In replacing the light, remove the front end of the light housing from the ceiling, replace the bulb with a new one, and reinstall the front end of the housing in its place.

Be sure to replace the nylon tape and insulation material.

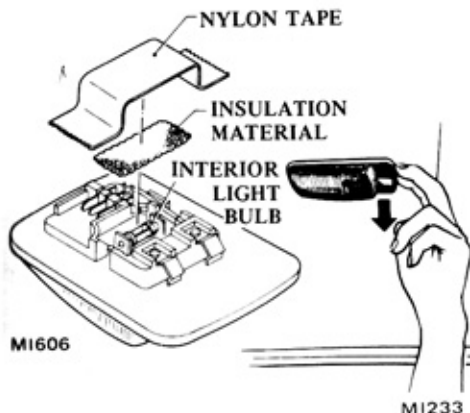

Luggage compartment light (Station Wagon)

In replacing the luggage compartment light, remove the lens unit by pulling it downward, and then replace the bulb with a new one.

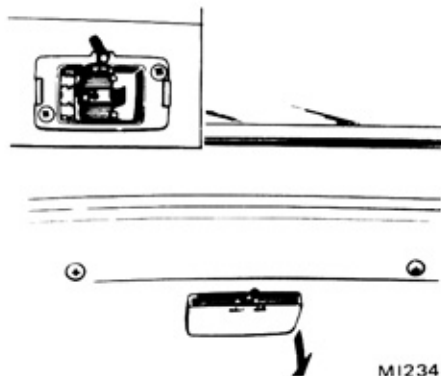

Trunk compartment light

To replace trunk compartment light, pull it downward and install a new bulb in its place.

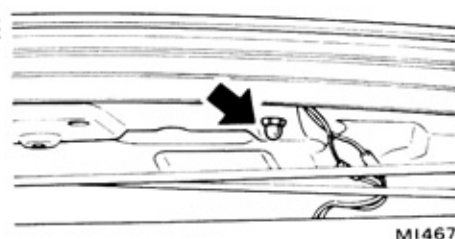

Maintenance

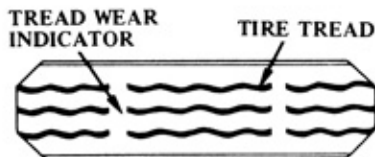

WH008

All tires and wheels on the car must be of the same size, type and load carrying capacity. For your safety, radial, belted or conventional type tires must not be mixed.

If you use snow-tires on your car, they must be of a size and type equal to the other tires on the car.

Tire rotation

The following tire rotation systems are recommended.

– Radial ply tires –

All the tires are of the same type.

• 5-tire rotation

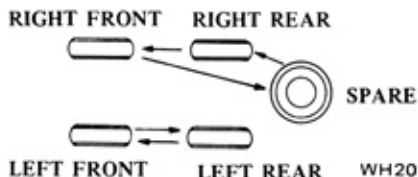

• 4-tire rotation

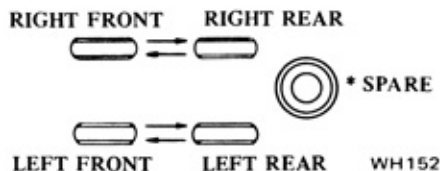

* Regardless of tire brand the spare tire should be used in an emergency only.

As to the tire rotation interval refer to the "Periodic Maintenance and Lubrication Schedule".

Changing tires

1. To change a tire, first apply the parking brakes. Block the wheel diagonally opposite the tire to be changed with a wheel chock.



2. Place the jack under one of the four jack-up points.

Note: Carefully read the caution label attached to the jack body.

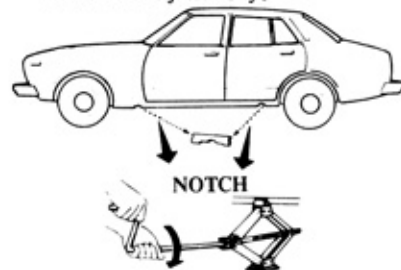

Sedan and Hardtop

JACK UP

TR027

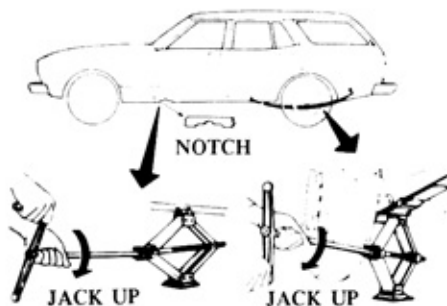

Station Wagon

TR028

Note: Remove the center cap by turning it in either direction.



WH197

- Using the wheel nut wrench, loosen the wheel nuts one or two turns each by turning them counterclockwise.

Note: Do not remove the wheel nuts until the wheel is raised off the ground.

- Raise the car until the wheel clears the ground, remove the wheel nuts, and replace the wheel.
- Tighten the wheel nuts alternately and evenly by turning them clockwise.

Be sure that the beveled end of the nuts face inward.

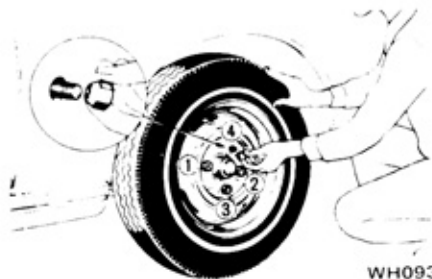

WH093



WH092

- Lower the car until the wheel touches the ground. Then securely tighten the wheel nuts in the same sequence as above.

Caution: Never get under a car while it is supported only by a jack.

Always use safety stands to support the frame when you have to get beneath the car.

- Replace the center cap, remove the wheel chocks, then replace the tools and spare tire.

Maintenance

Spare tire and tool/jack stowage

Sedan and Hardtop

The spare tire is located in the luggage compartment. Open the trunk lid and remove the rubber mat. Release the spare wheel clamp by turning it counterclockwise and remove the cover board.



WH216

The jack, jack handle, wheel chocks and the other tools are stowed in the luggage compartment at the left.

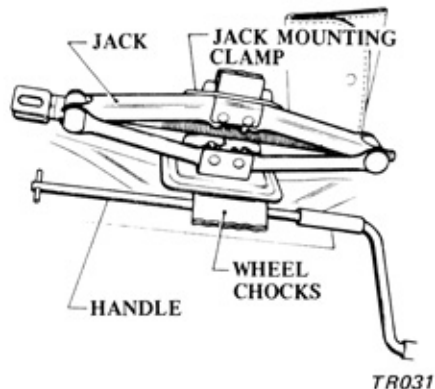

Sedan and Hardtop

Station Wagon

The spare tire is hung under the luggage floor.

To remove the tire, loosen the hanger bolt, lift the spare tire slightly and swing the hanger bolt to the right. To store the tire, manually lift the tire hanger, hook it on the hanger bolt and tighten the bolt securely.

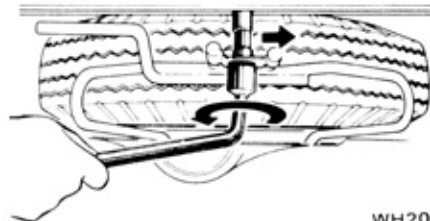

WH200

The tool bag installed under the driver's seat and the jack is installed under the front passenger seat.

Wheel chocks are installed under the rear seat.

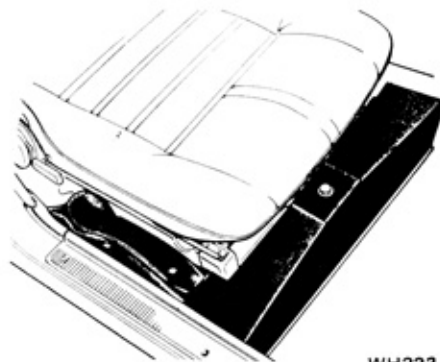

WH223

CLEANING YOUR CAR

The finish and upholstery on your car continually receives abuse from industrial fumes, dirt, mud, road salt, etc.

Yet your car will always look well-cared for if you follow these helpful hints on car care.

The best way to preserve the finish and maintain its original beauty is to keep it clean.

The longer dirt is left on the surface, the greater the probability of some damage to the finish.

In areas where excessive road salt is used, the car should be cleaned more often to protect the finish.

Washing your car

Spray water over the car to remove loose dirt.

Clean with a soft bristle brush and soap and water solution.

Rinse well. Wipe with a chamois to keep from water-spotting.

Removing spots

Remove spots from the painted surface as soon as possible to prevent staining.

Tar or road oil

Remove tar or oil immediately as permanent staining may result.

Use a tar and road oil remover. If you do not have a remover, use turpentine. Then wash with a soap and water solution. Wax to preserve the finish.

Insects or tree sap

Remove with a soap and water solution.

Waxing

Apply liquid wax or paste wax to obtain a long-lasting durable finish.

Wax at periodic intervals, depending on the environment where your car is used.

Leatherette and interior trim

Wipe leatherette and interior trim clean with a damp or wet cloth or use a recommended cleaner.

Caution: Make sure the cleaner selected is not harmful to the material.

Cloth upholstery and carpet

Clean with a vacuum cleaner or hard brush.

Stains should be removed with a soap and water solution or a spot remover.

Wipe with a damp clean cloth from outside of stain toward center.

Vinyl-covered Top

A vinyl-covered top should be washed often, using a soft natural bristle handscrub brush and laundry bar soap. After scrubbing, rinse with plenty of water to remove all dirt and suds.

Maintenance

PERIODIC MAINTENANCE AND LUBRICATION SCHEDULE

Before delivery of your new car, your dealer provides a pre-delivery inspection and adjustment service specified by the factory and designed to ensure satisfactory performance.

The following tables list the servicing required to keep your car operating at peak mechanical condition, and should be attended to as indicated, preferably by an authorized NISSAN/DATSUN dealer.

UNDERHOOD MAINTENANCE

MAINTENANCE OPERATION Periodic maintenance should be performed at number of kilometers or months whichever comes first	MAINTENANCE INTERVAL												
	Number of kilometers in thousands		1	10	20	30	40	50	60	70	80	90	100
	Number of months		1	6	12	18	24	30	36	42	48	54	60
Check battery terminals, fluids & specific gravity (2)	X	X	X	X	X	X	X	X	X	X	X	X	X
Check condition of cooling & fuel systems & Master-Vac hoses	X	X	X	X	X	X	X	X	X	X	X	X	X
Check level of fluid in brake & clutch master cylinders, engine, steering gear, windshield washer, radiator & automatic transmission	X	X	X	X	X	X	X	X	X	X	X	X	X
Check air conditioning system hoses, connections & refrigerant leaks	X	X	X	X	X	X	X	X	X	X	X	X	X
Change brake fluid (with disc brake)			X		X		X		X		X		X

NOTE: (2) More frequent maintenance if under drive in areas using road salt or other corrosive materials

UNDER VEHICLE MAINTENANCE

MAINTENANCE OPERATION Periodic maintenance should be performed at number of kilometers or months whichever comes first	MAINTENANCE INTERVAL												
	Number of kilometers in thousands		1	10	20	30	40	50	60	70	80	90	100
	Number of months		1	6	12	18	24	30	36	42	48	54	60
Check brake, clutch, fuel & exhaust systems for proper attachment, leaks, cracks, chafing, abrasion, deterioration, etc.	X	X	X	X	X	X	X	X	X	X	X	X	X
Check level of oil in manual transmission & differential gear		X	X	X	X			X	X	X	X	X	X
Check steering gear box & linkage, suspension parts & propeller shaft for damaged, loose & missing parts	X	X	X	X	X	X	X	X	X	X	X	X	X
Grease steering linkage & front suspension ball joints							X						X
Grease rear axle drive shaft joints							X						X

Check: Check, correct-replace if necessary

OUTSIDE AND INSIDE MAINTENANCE

MAINTENANCE OPERATION Periodic maintenance should be performed at number of kilometers or months whichever comes first	MAINTENANCE INTERVAL										
	Number of kilometers in thousands					Number of months					
	1	10	20	30	40	50	60	70	80	90	100
Check tire pressure and condition	X	X	X	X	X	X	X	X	X	X	X
Check headlight aiming & function of lamps		X	X	X	X	X	X	X	X	X	X
Check wheel alignment If necessary, rotate and balance wheels			X		X		X		X		X
Check disc brake pads & other internal brake components for wear, deterioration & leaks (2)			X	X	X	X	X	X	X	X	X
Check brake drums, linings & other internal brake components for wear, deterioration & leaks (2)			X		X		X		X		X
Repack front wheel bearing grease					X				X		
Check clutch & brake pedals & adjust if necessary (where adjustable) Check parking brake stroke	X	X	X	X	X	X	X	X	X	X	X
Check steering wheel for play		X	X	X	X	X	X	X	X	X	X
Lubricate locks, hinges & hood latch (2)		X	X	X	X	X	X	X	X	X	X
Check windshield wiper blades		X	X	X	X	X	X	X	X	X	X
Check seat belts, buckles, retractors, anchors, & adjuster		X	X	X	X	X	X	X	X	X	X

NOTE: (2) More frequent maintenance if under drive in areas using road salt or other corrosive materials

ROAD TEST

MAINTENANCE OPERATION Periodic maintenance should be performed at number of kilometers or months whichever comes first	MAINTENANCE INTERVAL										
	Number of kilometers in thousands					Number of months					
	1	10	20	30	40	50	60	70	80	90	100
Check foot brake, Master-Vac & NP-valve for operation Check others for condition	X	X	X	X	X	X	X	X	X	X	X

Emission Control Systems

FOREWORD

The control of automotive air pollution largely depends upon the development of effective emission control systems. To meet this demand, NISSAN has been making consistent and continuous efforts towards the further development of such devices.

Your DATSUN is equipped with emission control devices which are designed and built to provide emission performance levels required by Australian Design Rules.

In some States owners may be subject to penalties for any modifications made to the emission control systems after delivery.

MAINTENANCE RECOMMENDATION

Please make your contribution to clean air in our environment by operating the car within the prescribed passenger and load limits and by maintaining the emission control system in accordance with our recommendations.

To maintain the original quality built into the emission control system we recommend that the system be maintained by your DATSUN Dealer who uses only Genuine NISSAN Replacement Parts.

The use of other parts which may be inferior to Genuine NISSAN Parts could lead to a reduction in the effect of the system.

EMISSION CONTROL SYSTEM

All new DATSUNs are equipped with an emission control system which satisfies all applicable regulations.

With this emission control system built into DATSUN, the discharge of pollutants has been reduced substantially.

These pollutants are primarily hydrocarbons, nitrogen oxides and carbon monoxide.

Hydrocarbons and nitrogen oxides when exposed to sunlight under certain conditions produce photochemical smog.

Carbon monoxide is toxic when highly concentrated in the air.

The emission control system consists of (1) crankcase emission control system, (2) exhaust emission control system, and (3) evaporative emission control system.

The crankcase emission control system recirculates blow-by gases to the combustion chamber and prevents the emission of such unburnt gases into the air.

The exhaust emission control system insures that fuel is burned completely

and properly. The evaporative emission control system prevents evaporative

gases from escaping into the air. These systems are outlined below.

1. CRANKCASE EMISSION CONTROL SYSTEM

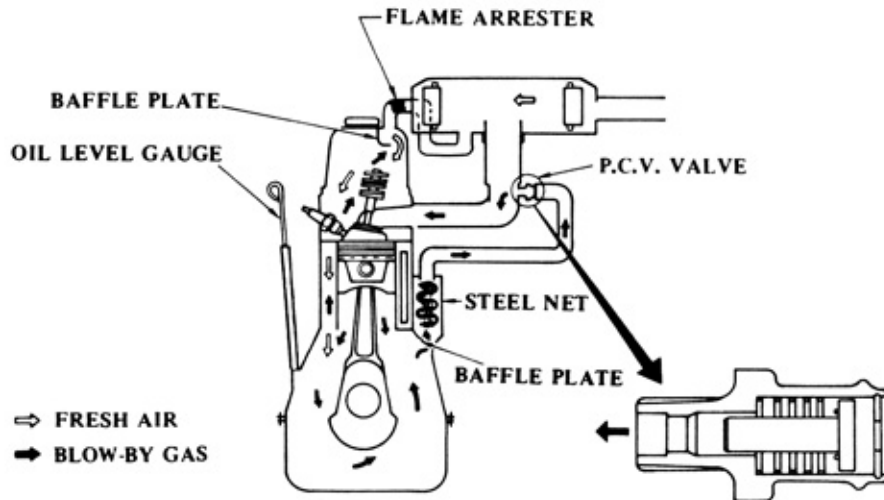

This system is designed to send blow-by gases back to the combustion chamber for reburning, and at the same time to send filtered air into the crankcase for ventilation. Thus, this system serves to prevent the emission of blow-

by gases into the atmosphere.

The function of this system depends upon the positive crankcase ventilation (P.C.V.) control valve which returns blow-by gases to the combustion chamber.

Emission Control Systems

2. EXHAUST EMISSION CONTROL SYSTEM

This system includes the following components.

- (1) Boost Controlled Deceleration Device (B.C.D.D.) (Manual transmission models only)
- (2) Exhaust Gas Recirculation (E.G.R.) Control System
- (3) Spark Timing Control System (Manual transmission models only)

Boost Controlled Deceleration Device (B.C.D.D.) (Manual transmission models only)

The function of the B.C.D.D. is to open the by-pass hole of the carburetor slightly during deceleration.

During deceleration, the air-fuel mixture ratio becomes unbalanced and normal combustion cannot continue.

Thus, a great amount of unburned hydrocarbons are emitted.

The B.C.D.D. supplies additional air into the intake manifold to balance the air-fuel mixture ratio and prevent such unburned hydrocarbons from being emitted.

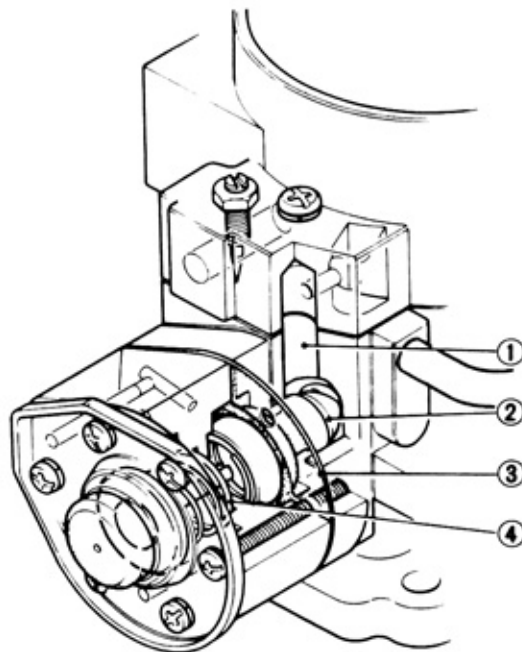

- ① Air passage
- ② Mixture control valve
- ③ Diaphragm
- ④ Vacuum control valve

EC514

Emission Control Systems

Exhaust Gas Recirculation (E.G.R.) Control System

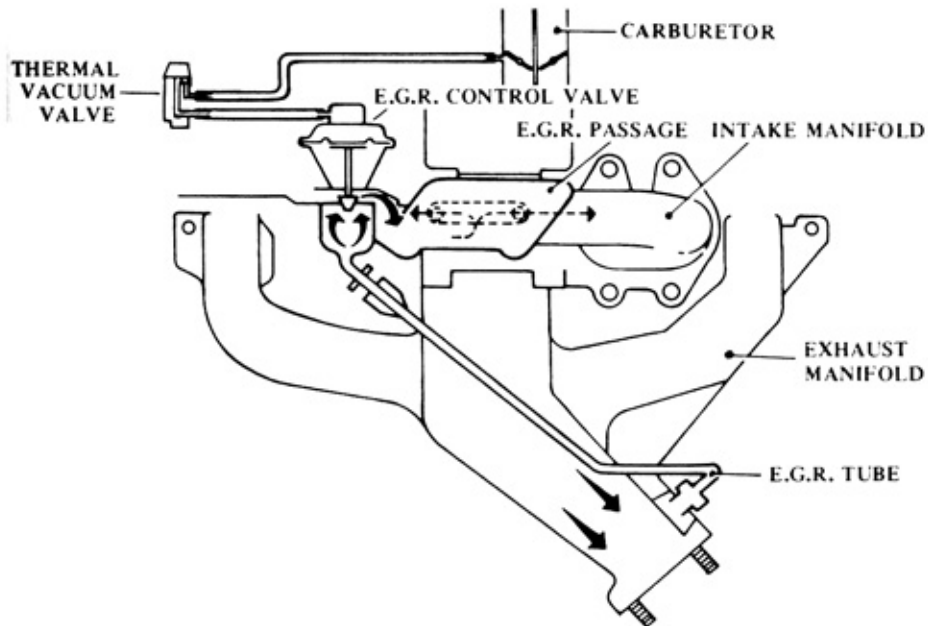

The purpose of the E.G.R. system is to control NO_x emission. This system recirculates part of the exhaust gas through the intake manifold and reduces NO_x by reducing the combustion temperature.

SY007

Emission Control Systems

Spark Timing Control System (Manual transmission models only)

This system controls the ignition advance angle to reduce NOx and HC. The system is controlled by the transmission shift position.

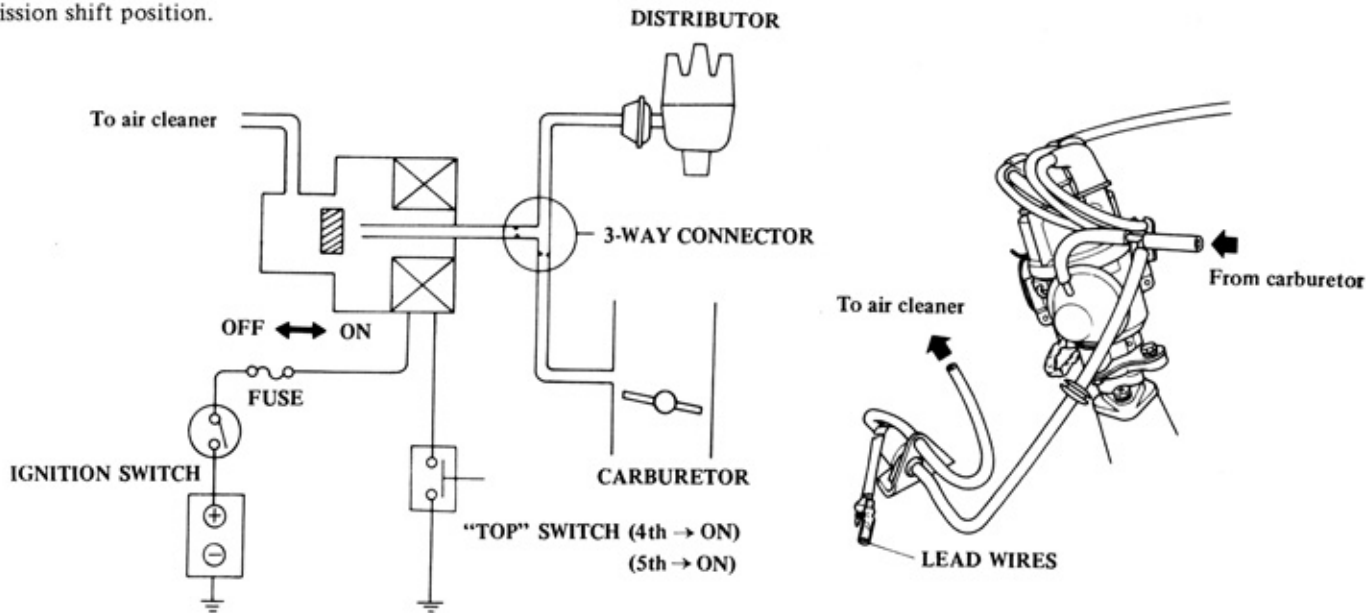

EC890

3. EVAPORATIVE EMISSION CONTROL SYSTEM

The evaporative emission control system prevents evaporative gases in the fuel tank from entering the atmosphere.

When the vacuum pressure in the fuel tank is too high, air passes through the vacuum relief valve in the fuel cap.

The vacuum relief valve prevents evaporative gases from being expelled into the atmosphere.

Therefore, evaporative gases are stored in the evaporative tank and the crankcase of the engine.

When the engine is running the stored evaporative gases are sucked into the carburetor through the P.C.V. valve.

SEDAN AND HARDTOP

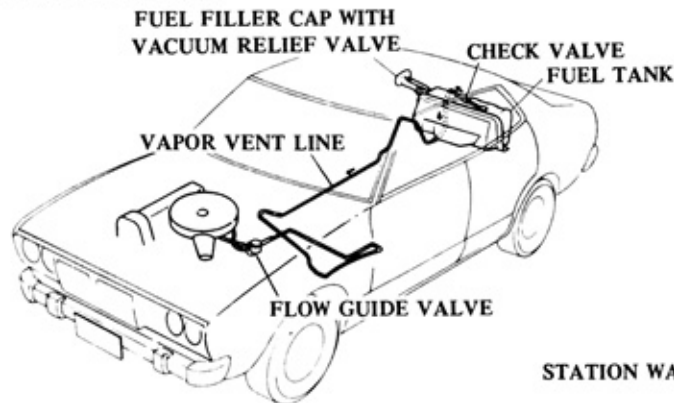

STATION WAGON

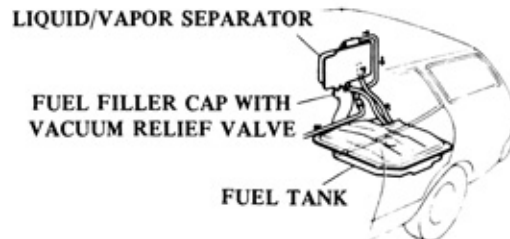

EC066A

Emission Control Systems

EMISSION CONTROL MAINTENANCE SCHEDULE

MAINTENANCE OPERATION (Periodic maintenance should be performed at number of kilometers or months whichever comes first)	Number of kilometers in thousands Number of months	MAINTENANCE INTERVAL										
		1	10	20	30	40	50	60	70	80	90	100
		1	6	12	18	24	30	36	42	48	54	60
1 Adjust intake & exhaust valve clearances		X		X		X		X		X		X
2 Check & adjust drive belts for cracks, fraying, wear & tension	Check		X	X	X	X	X	X	X	X	X	X
	Adjust	X										
3 Check cylinder head bolts, manifold nuts & carburetor securing nuts		X										
4 Change engine oil		X	Change every 5,000 km									
5 Replace engine oil filter		X	X	X	X	X	X	X	X	X	X	X
6 Change engine coolant (ethylene glycol base)	(3)					X				X		
7 Check engine for coolant, oil & fuel leaks	(2)	X	X	X	X	X	X	X	X	X	X	X
8 Check vacuum fitting hoses & connections				X		X		X		X		X
9 Check & adjust carburetor idle rpm & mixture ratio		X	X	X	X	X	X	X	X	X	X	X
10 Adjust choke mechanism (choke plate & linkage)		X		X		X		X		X		X
11 Replace fuel filter	(1)					X				X		
12 Inspect fuel lines (hoses, piping, connections, etc.)		X				X				X		
13 Replace air cleaner element (viscous paper type)	(1)					X				X		
14 Adjust ignition timing		X	X	X	X	X	X	X	X	X	X	X
15 Check distributor cap, rotor & condenser			X	X	X	X	X	X	X	X	X	X
16 Replace distributor breaker point				X		X		X		X		X
17 Check & replace spark plugs	Check		X		X		X		X		X	
	Replace			X		X		X		X		X
18 Check ignition wiring						X				X		
19 Check spark timing control system						X				X		
20 Check & replace P.C.V. valve	Check (1)			X				X				X
	Replace					X				X		
21 Check ventilation hoses				X		X		X		X		X
22 Check exhaust gas recirculation (E.G.R.) control system				X		X		X		X		X
23 Check vapor lines (hoses, connections, etc.) & fuel vapor control valve				X		X		X		X		X
24 Check fuel tank vacuum relief valve		X				X				X		

- NOTES: (1) More frequent maintenance if under dusty driving conditions
 (2) More frequent maintenance if under drive in areas using road salt or other corrosive materials
 (3) Or every 24 months

Check: Check, correct-replace if necessary

INSTRUCTIONS FOR EMISSION CONTROL MAINTENANCE SERVICE

These scheduled maintenance services should be performed at the designated service intervals in order to ensure good emission control performance and good engine performance in your new DATSUN.

THE FIRST 1,000 KM SERVICE IS ONE OF THE MOST IMPORTANT SERVICES REQUIRED TO ENSURE THE MAXIMUM EMISSION CONTROL PERFORMANCE AND OPTIMUM ENGINE CONDITION OF YOUR NEW DATSUN.

It is also important that emission control components be replaced at the designated time or odometer reading. If frequently used under unusual operating conditions (driving on a dusty road, disuse for long time, repeated travel less than several kilometers, short trips in freezing temperature, or towing a caravan or trailer), the car might require additional maintenance. For example, increased frequency of air cleaner filter replacements, cleaning or replacement of spark plugs, or changing of the oil

and oil filter may become necessary.

If maintenance service is required, or if your car exhibits malfunctions, or if the idle-adjustment is not correct, it is recommended that you have the systems checked and tuned by your DATSUN dealer.

A factory service manual – The one DATSUN dealer technician use – is available from your nearest DATSUN dealer.

Emission Control Systems

Maintenance Instructions

(1) Adjust intake and exhaust valve clearances

Proper adjustment of the valve clearance is essential to exhaust emission control.

Be sure to meet this requirement since valve noise or unstable idling may occur.

(2) Check and adjust drive belts for cracks, fraying, wear and tension

Check drive belts for wear, fraying or cracking and proper tension.

To check the proper tension of the drive belts, depress the belt at the recommended position to the specified value and observe the slack in the belt.

Replace the drive belts if found damaged.

(3) Check cylinder head bolts, manifold nuts and carburetor securing nuts

The above bolts and nuts should be correctly retightened to prevent air and/or exhaust gas leakage.

Emission Control Systems

(4) Change engine oil

Engine oil should be changed after the first 1,000 km and every 5,000 km or 3 months, whichever comes first.

(5) Replace engine oil filter

Engine oil filter should be replaced at the first engine oil change.

Thereafter it should be replaced with every second oil change.

(6) Change engine coolant (Ethylene glycol base)

The engine coolant should be checked for proper level.

Engine coolant including permanent anti-freeze coolant (Ethylene glycol base) should be changed every 40,000 km or 24 months, whichever comes first.

Whenever the coolant is changed, the cooling system must be flushed and refilled.

(7) Check engine coolant, oil and fuel leaks

Check the cooling system hoses and connections for damage or looseness.

If a leaky hose or connection is found, replace it.

Check the fuel hoses, piping and connections for damage, leaks or looseness.

Replace any damaged parts.

(8) Check vacuum fitting hoses and connections

Check hoses and connections for looseness or damage.

If a deteriorated or damaged hose is found, replace it.

(9) Check and adjust carburetor idle rpm and mixture ratio

Adjustment should be made with a CO-meter and tachometer to ensure accuracy.

Satisfactory operation of the carburetor is of prime importance in the control of emissions.

Proper mixture and idle rpm have been set at the factory.

(10) Adjust choke mechanism (choke plate and linkage)

Check for smooth operation of the choke plate and linkage.

In almost all cases, improper operation of these parts is caused by a sticking valve or binding linkage resulting from combustion residue.

(11) Replace fuel filter

The fuel filter should be changed every 40,000 km or 24 months, whichever comes first.

(12) Inspect fuel lines (hoses, piping, connections, etc.)

Check the fuel hoses, piping and connections for damage, leaks or looseness.

Replace any damaged parts.

Emission Control Systems

(13) Replace air cleaner element (viscous paper type)

Under normal driving conditions, the carburetor air cleaner element should be replaced every 40,000 km or 24 months, whichever comes first.

However, driving the car in dusty areas will cause rapid clogging of the element. Consequently, the element may have to be replaced more frequently.

(14) Adjust ignition timing

Ignition timing must be adjusted with the proper equipment. Whenever ignition timing is adjusted, the distributor breaker point gap should also be adjusted.

(15) Check distributor cap, rotor and condenser

Check the distributor cap and rotor for cracks, carbon formation or erosion.

(16) Replace distributor breaker points

The distributor breaker points should be replaced every 20,000 km or 12 months, whichever comes first.

When replacing the distributor breaker point, apply grease to cam heel.

(17) Check and replace spark plugs

The spark plugs should be replaced with new ones every 20,000 km or 12 months, whichever comes first.

The spark plug gap should be checked whenever the engine idle is adjusted.

If the electrodes are badly worn or excessively fouled, replace the spark plugs.

Make sure that the spark plugs should be replaced with those of the proper rating.

(18) Check ignition wiring

Check the ignition wiring for cracks of exterior insulation and for a proper fit on the distributor cap and spark plugs.

(19) Check spark timing control system

Check for proper operation of the spark timing control system.

Check the spark timing by changing the gear position from 4th or 5th to the other gear position while depressing the clutch pedal.

(20) Check and replace P.C.V. valve

The P.C.V. valve should be checked for proper operation and for signs of clogging.

If the P.C.V. valve is clogged, clean or replace it.

The P.C.V. valve should also be replaced with a new one every 40,000 km or 24 months, whichever comes first.

(21) Check ventilation hoses

The ventilation hoses should be blown out with air to make certain that it is clean when the P.C.V. valve is replaced. Ensure that the flame arrester is securely inserted in the hose between the air cleaner and the rocker cover.

Emission Control Systems

(22) Check exhaust gas recirculation (E.G.R.) control system

Check the movement of E.G.R. control valve during engine warming-up period.

At the same time, remove and clean the E.G.R. control valve seat since it may be damaged with carbon deposits. Replace if necessary.

(23) Check vapor lines (hoses, connections, etc.) and fuel vapor control valve

Check vapor lines and connections for failure or looseness.

If leaks are found, replace them.

At the same time check the function of the flow guide valve.

(24) Check fuel tank vacuum relief valve

A damaged vacuum relief valve may sometimes leak evaporative gas or cause fuel tank deformation. If replacement of the valve becomes necessary, replace the fuel filler cap assembly.

EMISSION CONTROL TROUBLE SHOOTING CHART

The chart shown below will be extremely helpful in trouble shooting the emission control system of your Datsun. Whenever the condition of any part of the emission control system is questionable, utilize this chart as a guide to locate and correct the cause of trouble.

Satisfactory performance and operation of the emission control system are assured only when the system is properly cared for.

Notes:

- a) Before checking or repairing any part of the emission control system, ensure that all safety precautions are taken.
- b) Idling and ignition timing adjustments require the use of special equipment or instruments.

Condition	Probable cause	Corrective action
Cannot crank engine or slow cranking.	Discharged or damaged battery. Loose connection. <ul style="list-style-type: none"> ● Battery ● Starting motor Damaged starting motor.	Charge or replace. Check both cable connections on battery and grounded end. Check connections at magnetic switch mounted on starting motor. Repair or replace.
Engine will crank normally but will not start.	Ignition system Loose connection in ignition system.	Check for loose connections at ignition coil, distributor and spark plugs.

Emission Control Systems

Condition	Probable cause	Corrective action
	<p>Weak spark or no spark occurs on spark plugs.</p> <p>Test procedure. Disconnect high tension cable from one spark plug and hold it about 10 mm (0.39 in) from engine block and crank engine.</p> <p>Note: Hold high tension cable with dry piece of cloth.</p> <p>Fuel system No fuel in fuel line. Clogged fuel line. Malfunction of auto-choke mechanism.</p>	<p>If good spark occurs. Check spark plugs and clean or replace. Check fuel system and clean or repair. Check ignition timing. Check cylinder compression.</p> <p>If weak spark or no spark occurs. Check and clean distributor cap and rotor. Check ignition system.</p> <p>Check fuel level. Refill if necessary. Check for clogged fuel filter and piping. Adjust auto-choke mechanism.</p>
High engine idle speed.	<p>Stuck dash pot. Binding accelerator linkage. Incorrect idle adjustment. Malfunction in boost controlled deceleration device. Malfunction in auto-choke.</p>	<p>Adjust or replace dash pot. Check and correct accelerator linkage. Adjust idle speed. Check for set pressure. Replace system components if necessary. Adjust or replace auto-choke components.</p>

Emission Control Systems

Condition	Probable cause	Corrective action
Rough or unstable engine idle.	Incorrect idle adjustment. Improper auto-choke setting. Improper valve clearance. Clogged air cleaner filter. Loose manifold and cylinder head bolts. Malfunction of E.G.R. control valve. Malfunction of idle compensator.	Adjust idle speed. Adjust. Adjust valve clearance. Replace. Retighten bolts. Clean valve seat of E.G.R. control valve. Replace.
Engine knocking.	Use of fuel with insufficient octane rating. Laboring engine.	Exchange for recommended fuel. Check ignition timing if necessary. Select a lower gear.
Back fire or after fire.	Irregular combustion. Damaged E.G.R. control valve.	Check spark plugs for gap, carbon deposit or incorrect heat range. Check ignition timing. Replace.
Charge warning light turns on while driving.	Loose connection. Loose fan belt. Damaged alternator or voltage regulator.	Check for loose connections of alternator and voltage regulator. Adjust belt tension. Repair or replace alternator or voltage regulator.

Emission Control Systems

EMISSION LABEL

In accordance with emission requirements of the ADR regulation, a label is attached to the rear side of the engine hood.

Manual transmission model

VEHICLE EMISSION CONTROL INFORMATION

THIS VEHICLE CONFORMS TO AUSTRALIAN DESIGN RULE
27A VEHICLE EMISSION CONTROL.

- ENGINE.....FAMILY: L20B CODE: L20B-M
- EXHAUST EMISSION CONTROL TYPE.....E.M.S. + E.G.R.
- ENGINE TUNE UP SPECIFICATION AND ADJUSTMENT
(LIGHTS AND ACCESSORIES OFF)

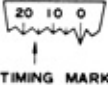

TIMING MARK

- IDLE SPEED.... 700 R.P.M. IN NEUTRAL
- IGNITION TIMING.....16° B. T. D. C.
- SPARK PLUG GAP.....1.1mm
- DISTRIBUTOR POINTS GAP...0.5mm
- MIXTURE SETTING... CO 2% ± 0.5 AT IDLE

NISSAN MOTOR CO., LTD.

14805 U9401⑧ L20B M/T

Automatic transmission model

VEHICLE EMISSION CONTROL INFORMATION

THIS VEHICLE CONFORMS TO AUSTRALIAN DESIGN RULE
27A VEHICLE EMISSION CONTROL.

- ENGINE.....FAMILY: L20B CODE: L20B-A
- EXHAUST EMISSION CONTROL TYPE.....E.M.S. + E.G.R.
- ENGINE TUNE UP SPECIFICATION AND ADJUSTMENT
(LIGHTS AND ACCESSORIES OFF)

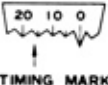

TIMING MARK

- IDLE SPEED.... 750 R.P.M. IN "N" RANGE
- IGNITION TIMING.....16° B. T. D. C.
- SPARK PLUG GAP.....1.1mm
- DISTRIBUTOR POINTS GAP...0.5mm
- MIXTURE SETTING... CO 2% ± 0.5 AT IDLE

NISSAN MOTOR CO., LTD.

14805 U9411⑦ L20B A/T

CAR IDENTIFICATION PLATE LOCATION

The car identification plate is located at the center of the cowl top in the engine compartment.

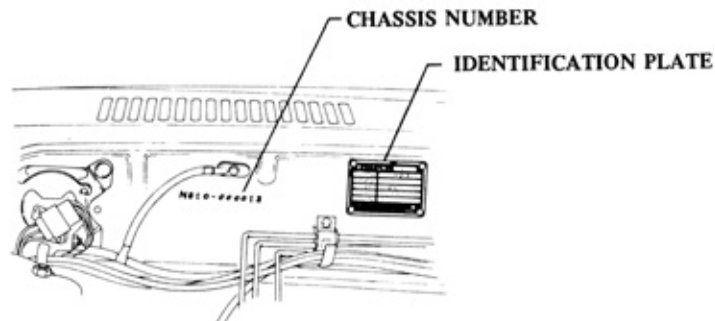

G1365

CHASSIS NUMBER LOCATION

The number is stamped on the right side of the cowl top and is broken down as illustrated below.

On the Sedan, the number is stamped on the top face of the inner mudguard panel at the passenger side.

Specifications ENGINE SERIAL NUMBER LOCATION

The engine serial number is stamped on the cylinder block in the manner as shown.

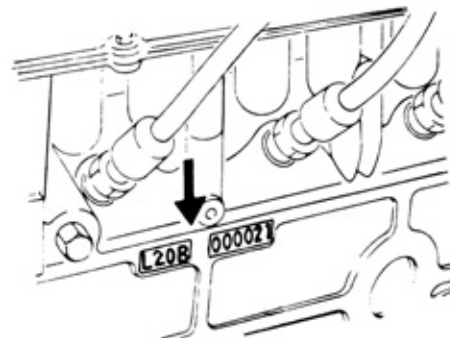

G1366

Specifications

GENERAL SPECIFICATIONS

	Sedan	Hardtop	Station Wagon	
DIMENSIONS mm (in)				
Overall length	4,260 (167.7)	4,260 (167.7)	4,310 (169.7)	
Overall width	1,630 (64.2)	1,630 (64.2)	1,630 (64.2)	
Overall height	1,390 (54.7)	1,380 (54.3)	1,415 (55.7)	
Wheelbase	2,500 (98.4)	2,500 (98.4)	2,500 (98.4)	
WEIGHTS (Curb) kg (lb)				
Car model				
Sedan	Manual transmission		1,090 (2,403)	
	Automatic transmission		1,098 (2,421)	
Hardtop	Manual transmission		1,090 (2,403)	
	Automatic transmission		1,098 (2,421)	
Station Wagon				
	Manual transmission		1,125 (2,481)	
	Automatic transmission		1,133 (2,498)	
Seating capacity	5	5	5	
ENGINE	4 cylinder in-line, 4 cycle, O.H.C.			
TRANSMISSION	Manual, Automatic			
	Gear ratio			
	Manual		Automatic	
	4-speed	5-speed	3N71B	BW35
1st	3.382	3.382	2.458	2.393
2nd	2.013	2.013	1.458	1.450
3rd	1.312	1.312	1.000	1.000
4th	1.000	1.000	—	—
5th	—	0.854	—	—
Rev. ...	3.364	3.570	2.182	2.094

Specifications

GEAR CARRIER

Gear ratio

Sedan	3.889
Hardtop	3.900, 4.111
Station Wagon	4.111

TIRE and WHEEL

Model	Tire size	Wheel size
Sedan Deluxe	6.45S14	5JJ-14
Sedan GL/GX, Station Wagon Hardtop	165SR14 185/70HR14	or 5J-14 [Offset 30 mm (1.18 in)]

Specifications

ENGINE DATA

Engine model		L20B
Piston displacement	cc (cu in)	1,952 (119.1)
Bore x Stroke	mm (in)	85 x 86 (3.35 x 3.39)
Compression ratio		8.5
Firing order		1-3-4-2
Idling speed	rpm	
Manual transmission		700
Automatic transmission		750
Ignition timing (BTDC)	degree/rpm	
Manual transmission		16°/700
Automatic transmission (in "N" position)		16°/750
Distributor point gap	mm (in)	0.45 to 0.55 (0.018 to 0.022)
Distributor point dwell	degree	49 to 55°
Spark plug gap	mm (in)	1.0 to 1.1 (0.039 to 0.043)
Valve clearance (Hot)	mm (in)	
Intake		0.25 (0.010)
Exhaust		0.30 (0.012)
Cylinder head bolt tightening torque	N-m (ft-lb)	69 to 83 (51 to 61)
Manifold nut tightening torque	N-m (ft-lb)	12 to 16 (9 to 12)
Fan belt deflection	mm (in)	8 to 12 (0.31 to 0.47)
Fan belt size		
Width x Length	mm (in)	11.2 x 900 (0.441 x 35.43)

Specifications

CAPACITIES

	Liter	Imp measure
Fuel tank		
Sedan and Hardtop	60.0	13 $\frac{1}{4}$ gal
Station Wagon	55.0	12 $\frac{1}{8}$ gal
Cooling system		
Without heater	6.8	6 qt
With heater	7.5	6 $\frac{3}{8}$ qt
Engine oil		
Without oil filter change	3.8	3 $\frac{3}{8}$ qt
With oil filter change	4.3	3 $\frac{3}{4}$ qt
Transmission		
Manual 4-speed transmission	2.1	3 $\frac{3}{4}$ pt
5-speed transmission	2.0	3 $\frac{1}{2}$ pt
Automatic 3N71B	5.5	4 $\frac{7}{8}$ qt
BW35	7.3	6 $\frac{3}{8}$ qt
Rear axle (Differential carrier)		
Sedan and Hardtop	0.8	1 $\frac{3}{8}$ pt
Station Wagon	1.0	1 $\frac{1}{4}$ pt
Steering gear	0.28	$\frac{1}{2}$ pt
Windshield washer tank	2.2	2 qt
Rear window washer tank (Station Wagon)	1.5	1 $\frac{3}{8}$ qt
Air conditioning system		
Compressor oil	250 cc	8.8 fl oz
Refrigerant	1.0 kg (2.2 lb)	

NOTES:

Original Owner's Name: Phone Number:

Owner's Address:

Purchase Date:

Dealer's Name: Phone Number:

Dealer's Address:

Car Model: Color:

Chassis Number:

Engine Number:

Registration Number: Key Number:

Subsequent Owner's Name: Phone Number:

Owner's Address:

Purchase Date:

Mileage shown on Speedometer on Day of Purchase:

.....

.....

.....

.....



A large rectangular box containing 20 horizontal dotted lines, spaced evenly down the page, intended for handwriting practice. The lines are parallel and extend across most of the width of the box.



Index

ACCELERATOR PEDAL	12, 13	GENERAL SPECIFICATIONS	84 to 87	PUSH STARTING	46
AIR CLEANER ELEMENT	55	GLOVE BOX	12, 13	RADIO	12, 13, 14, 15, 38, 39
AIR CONDITIONER	36, 37	GLOVE BOX LOCK	3, 43	REARVIEW MIRRORS	11
ASH TRAYS	12, 13, 41	HAZARD WARNING FLASHER	45	REAR WINDOW ELECTRIC DEFROSTER SWITCH	12, 38
ASSIST GRIPS AND COAT HANGERS	42	HAZARD WARNING SWITCH	12, 13, 21	REAR WINDOW WIPER AND WASHER SWITCH	12, 21
AUTOMATIC TRANSMISSION FLUID	54	HEAD RESTRAINTS	6	RECOMMENDED ENGINE OIL VISCOSITY	52
BACK-UP BUZZER	27	HEATER	12, 13, 34, 35, 36	RECOMMENDED LUBRICANTS	53
BATTERY ELECTROLYTE LEVEL	50, 51	HIGH BEAM INDICATOR LIGHT	14, 15, 18	RECOMMENDED SAE VISCOSITY NUMBER	52
BRAKE AND CLUTCH FLUID LEVEL	50	HOOD LOCK	54	ROOM LIGHT (Interior light)	41
BRAKE PEDAL	12, 13, 57	HOOD RELEASE HANDLE	12, 13	ROUTINE SERVICE	48 to 51
BRAKE WARNING LIGHT	14, 15, 17, 18	HORN	12, 13, 22	SAFETY CHECKS	2
BREAK-IN SCHEDULE	23, 24	IGNITION KEY ILLUMINATION LIGHT	12, 13, 20	SEAT BELTS	6 to 8
BULB REPLACEMENT	59 to 61	IGNITION SWITCH	3, 25	SIDE VENTILATOR	12, 13
BULB SPECIFICATIONS	58	ILLUMINATION CONTROL RHEOSTAT	12, 13, 20	SPARE TIRE AND TOOL/JACK STOWAGE	64
CAR IDENTIFICATION PLATE LOCATION	83	IN COLD WEATHER	31, 32	SPARK PLUGS	56
CHANGING TIRES	62, 63	IN HOT WEATHER	32	SPEEDOMETER	14 to 16
CHARGE (Alternator) WARNING LIGHT	14, 15, 18	INSTRUCTIONS FOR EMISSION CONTROL MAINTENANCE SERVICE	75 to 78	STARTING THE ENGINE	24 to 26
CHASSIS NUMBER LOCATION	83	JUMP STARTING WITH BOOSTER BATTERY	46, 47	STEERING WHEEL	57
CHILD RESTRAINT	9	KEYS		STEREO TAPE PLAYER	39, 40
CIGARETTE LIGHTER	12, 13, 40	Door lock	3, 4	SUN VISOR	42
CLEANING YOUR CAR	65	Fuel filler lid lock	3, 4	TACHOMETER	15, 16
CLOCK	14, 15, 40	Glove box lock	3, 43	TAILGATE LOCK	44
CLUTCH PEDAL	12, 13, 57	Ignition switch	3, 25	TIPS ON DRIVING	30
COIN HOLDER	12, 13, 42	Steering lock	3, 25	TIRE CARE	61
CONSOLE BOX	43	Trunk lid/tailgate lock	3, 44	TIRE INFLATION PRESSURES	51
COOLING FAN BELT	55	LIGHT SWITCH	12, 13, 19	TIRE ROTATION	62
DISTRIBUTOR BREAKER POINT	56	LUGGAGE COMPARTMENT LIGHT	41	TOWING A TRAILER	10
DOOR LOCKS	3, 4	METERS AND GAUGES		TOWING THE CAR	45, 46
DRIVING WITH AUTOMATIC TRANSMISSION	28, 29	Fuel gauge	14 to 16	TRIPMETER	14, 15
DRIVING WITH MANUAL TRANSMISSION	27, 28	Odometer	14, 15	TRIPMETER RESET KNOB	14, 15
EMISSION CONTROL MAINTENANCE SCHEDULE	74	Oil pressure gauge	15, 16	TRUNK LID LOCK	3, 43
EMISSION CONTROL SYSTEM	69 to 73	Speedometer	14 to 16	TRUNK LID OPENER	43, 44
EMISSION CONTROL TROUBLE SHOOTING CHART	79 to 81	Tachometer	15, 16	TURN SIGNAL INDICATOR LIGHT	14, 15, 17
EMISSION LABEL	82	Tripmeter	14, 15	TURN SIGNAL SWITCH	12, 13, 19
ENGINE COOLANT LEVEL	49	Voltmeter	15, 16, 17	VENTILATION SYSTEM	33
ENGINE COOLING SYSTEM	55	Water temperature gauge	14 to 16	VOLTMETER	15, 16, 17
ENGINE OIL LEVEL	48, 49	MINOR MAINTENANCE	54 to 61	WARNING AND INDICATOR LIGHTS	
ENGINE OIL RECOMMENDATION	52	ODOMETER	14, 15	Brake warning light	14, 15, 17, 18
ENGINE SERIAL NUMBER LOCATION	83	OIL AND FUEL RECOMMENDATION	52, 53	Charge (Alternator) warning light	14, 15, 18
FOLDING REAR SEAT	44	OIL FILTER	55	Hazard warning flasher	45
FREEDING IMMOBILIZED CAR	45	OIL PRESSURE GAUGE	15, 16	High beam indicator light	14, 15, 18
FRONT SEAT	4, 5	OIL PRESSURE WARNING LIGHT	14, 18	Oil pressure warning light	14, 18
FUEL FILLER LID LOCK	3, 4	OPENING THE HOOD	48	Turn signal indicator light	14, 15, 17
FUEL GAUGE	14 to 16	PACKAGE TRAY	12, 13	WATER TEMPERATURE GAUGE	14 to 16
FUEL RECOMMENDATION	52	PARKING BRAKE	58	WHEEL AND TIRE	61 to 64
FUSES	58	PARKING BRAKE LEVER	12, 13, 22	WINDOW CONTROL	43
GAS STATION INFORMATION	Back covered page	PASSING LIGHT SWITCH	12, 13, 20	WIPER BLADES	56
GEAR CONTROL LEVER	12, 13	PERIODIC MAINTENANCE AND LUBRICATION SCHEDULE	66, 67	WINDSHIELD/REAR WINDOW WASHER	

SERVICE STATION INFORMATION

FUEL FILLER CAP

It is located at right rear side of the car.



FUEL RECOMMENDATION

Use a proper grade fuel of 88 octane number for all models.

HOOD RELEASE

Pull the hood release handle located below the instrument panel and release the safety catch and raise the hood by hand.

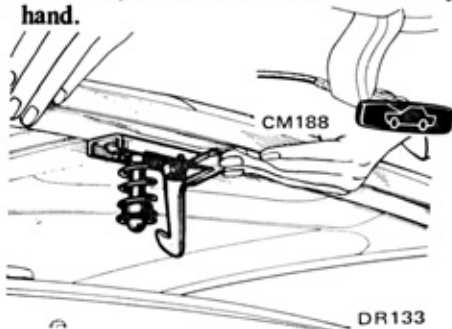

ENGINE OIL DIPSTICK AND FILLER CAP ①

The engine oil dipstick is located on the right side of the cylinder block. The best time to check it is before operating the engine or as the last step in a fuel stop. Maintain the oil level between "H" and "L" marks on the dipstick.

ENGINE OIL RECOMMENDATION

Use only recommended engine oil. See page 52 for oil viscosity chart.

BRAKE ② and CLUTCH ③ FLUID

Check brake and clutch reservoir fluid level.

Use only recommended fluid. See page 53 for brake and clutch fluid.

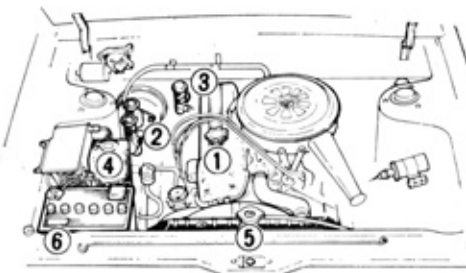

WINDSHIELD WASHER AND REAR WINDOW WASHER ④

Check reservoir fluid level. Always use Nissan Windshield Washer Liquid or equivalent.

ENGINE COOLANT ⑤

Check engine coolant level.

BATTERY FLUID ⑥

Check battery fluid level. If fluid level is low, add distilled water.

TIRE INFLATION PRESSURE

Keep tires inflated to pressures shown on page 51.

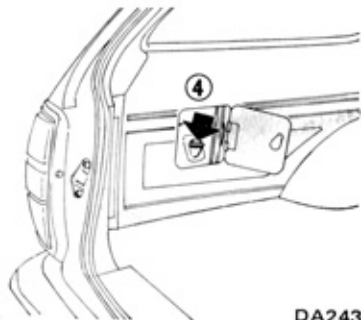

810-H



Printed in Japan

Issued: December 1977 (040900)
Publication No. OM8E-0810A3

NISSAN MOTOR CO., LTD. Tokyo, Japan